



**cosmos<sup>®</sup>**

Furniture Accessories

2021



Dear friends,

We are Cosmos Furniture Accessories Company based in Istanbul/Turkey. As a company, we are happy to be collaborating with you since 1992. With the 26 years of experience in furniture accessories sector, we became one of the most valuable companies among Turkish manufacturers and traders. Under the guidance of our principles, İlkay Accessoires targets developing and improving it's structure with the philosophies of becoming a brand name not only in local but in international markets providing on time high quality service with customer satisfaction. İlkay Furniture Accessories wishes you productive business and long term collaboration.

Sevgili arkadaşlar,

İstanbul / Türkiye merkezli Cosmos Mobilya Aksesuarları Şirketiyiz. Şirket olarak 1992'den beri sizlerle işbirliği yapmaktan mutluluk duyuyoruz.

Mobilya aksesuarları sektöründeki 26 yıllık tecrübemizle Türk üretici ve tüccarları arasında en değerli firmalardan biri olduk. İlkay Accessoires, ilkelerimizin kılavuzluğunda, sadece yerel değil, uluslararası pazarlarda da müşteri memnuniyeti ile zamanında kaliteli hizmet sunan bir marka olma felsefesi ile yapısını geliştirmeyi ve geliştirmeyi hedeflemektedir. İlkay Mobilya Aksesuarları size verimli işler ve uzun vadeli işbirliği diler.

General Manager  
Umut Olcay Aydın



[www.ilkyfurniture.com](http://www.ilkyfurniture.com)  
[www.ilkyaksesuar.com](http://www.ilkyaksesuar.com)  
[www.cosmosaks.com](http://www.cosmosaks.com)  
[info@cosmosaksesuar.com](mailto:info@cosmosaksesuar.com)  
[info@ilkyaksesuar.com](mailto:info@ilkyaksesuar.com)  
[export@ilkyfurniture.com](mailto:export@ilkyfurniture.com)

Cevatpaşa Mahallesi, Kartal Sokak,  
No. 8/A  
Bayrampaşa/İstanbul.  
Tel/Fax : 0 (212) 649 00 38  
GSM : +90 (530) 289 69 89

let's explore the cosmos green.

### 101 Elmas (Mineli)



Boy/Renk	Krom	Altın/Rose
Düğme	12.05	12.90
Sarkaç	13.45	15.20
128	17.90	20.75
160	22.60	26.50

50  400

### 102 Sardunya (Mineli)



Boy/Renk	Krom	Altın/Rose
Düğme	12.05	12.90
96	17.20	20.05
128	18.30	21.45

50  400

### 103 Burgu (Mineli)



Boy/Renk	Krom	Altın/Rose
96	14.60	18.05
128	18.30	21.45
160	20.45	24.35

50  400

### 104 Safir (Mineli)



Boy/Renk	Krom	Altın/Rose
Düğme	8.45	9.60
96	14.30	17.20
128	16.90	20.75

50  400



**105** Elmas



Boy/Renk	Altın/Beyaz	Altın/Siyah
Düğme	14.40	15.25
Sarkaç	14.40	15.25
128	18.60	20.30
160	25.35	27.05

50 400

**106** Sardunya



Boy/Renk	Altın/Beyaz	Altın/Siyah
96	20.30	20.30
128	22.00	22.00

50 400

**107** Patara



Boy/Renk	Altın/Beyaz	Altın/Siyah
160	19.45	19.45
224	22.85	22.85

50 400

**108** Kelebek



Boy/Renk	Altın/Beyaz	Altın/Siyah
160	20.30	20.30

50 400

### 109 Patara Kumlu

50  400

Boy/Renk	Krom	Altın
160	10.85	13.20
224	14.55	16.90

### 110 Patara

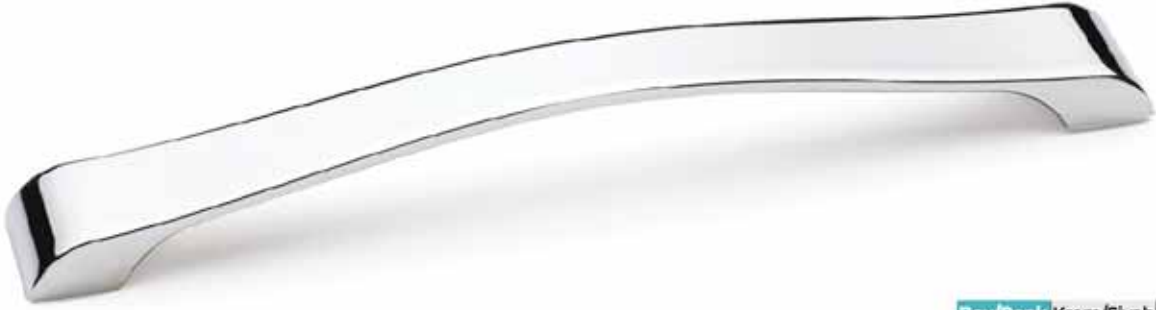
50  400

Boy/Renk	Krom/Siyah	Altın
160	11.70	14.40
224	16.10	19.45

### 111 Meltem Kumlu

50  400

Boy/Renk	Krom	Altın
160	12.00	14.20
224	15.25	17.60

### 112 Meltem

50  400

Boy/Renk	Krom/Siyah	Altın
160	13.05	16.40
224	16.85	20.65

**113** Güz



50 400

Boy/Renk	Krom/Siyah	Altın
64	17.25	19.95

**114** Yağmur

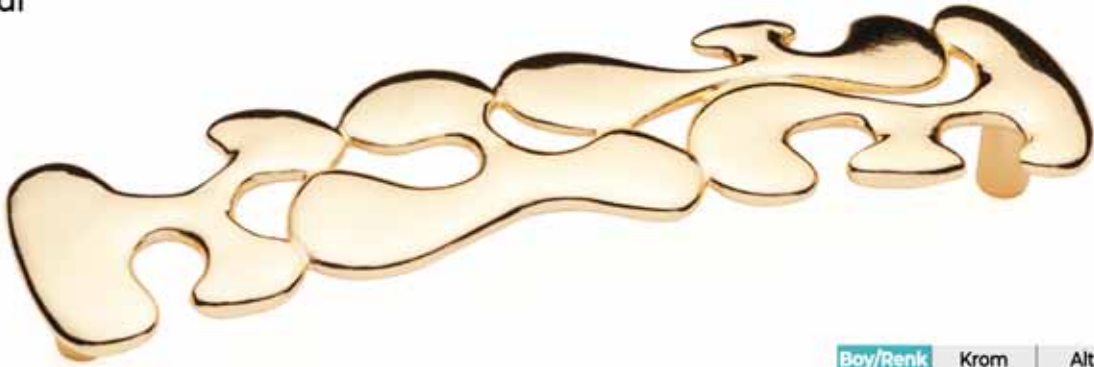

50 400

Boy/Renk	Krom	Altın	Antik
128	12.55	14.70	12.55
160	13.20	15.40	13.20

**115** Burgu (Kumlu)

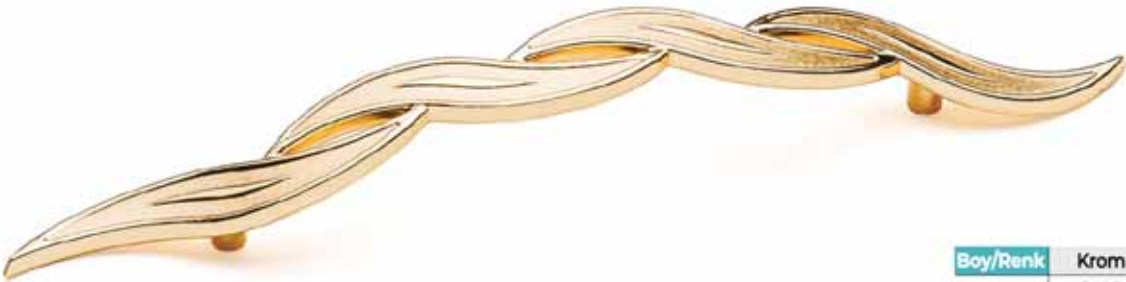

50 400

Boy/Renk	Krom	Altın
128	9.40	11.90
160	10.20	12.80
192	13.10	16.10

**116** Burgu



50 400

Boy/Renk	Krom/Siyah	Altın
96	6.40	8.95
128	9.40	11.90
160	10.20	12.80
192	13.10	16.10



### 117 Asaf



Boy/Renk	Krom	Altın	Rose/Bronz
160	22.10	26.00	27.30
224	26.00	28.60	31.20

50  400

### 118 Tomris



Boy/Renk	Krom	Altın	Rose/Bronz
160	22.10	26.00	27.30
224	26.00	28.60	31.20

50  400

### 119 Stella



Boy/Renk	Krom	Altın	Rose/Bronz
64	16.25	19.50	21.20
128	29.90	26.00	32.50

50  400

### 120 Rubi



Boy/Renk	Krom	Altın	Rose/Bronz
128	23.40	28.60	29.90
192	28.60	32.50	33.80

50  400



**121** Eksen



75 600

Boy/Renk	Krom/Antik	Altın/Füme	Beyaz/Siyah
96	9.75	11.70	9.75
128	11.40	13.35	11.40

**122** Tetra



20 160

Boy/Renk	Krom/Siyah	Altın/Füme	Antik/Rose
Düğme	42.00	48.00	48.00

**123** Eliza



50 400

Boy/Renk	Krom/Siyah	Altın	Rose/Bronz
96	7.80	9.75	11.70

**124** Star



50 400

Boy/Renk	Krom/Siyah	İnox
192	12.00	13.25

**125** Mimoza
50  400

Boy/Renk	Krom/Siyah	Altın	Antik
160	<b>11.90</b>	<b>15.00</b>	<b>15.00</b>

**126** Açelya
50  400

Boy/Renk	Krom/Siyah	Altın	Antik
160	<b>9.50</b>	<b>11.75</b>	<b>11.75</b>

**127** Riva Taşlı
40  320

Boy/Renk	Krom/Siyah	Altın	Antik
Sarkaç	<b>8.50</b>	<b>10.50</b>	<b>10.50</b>
128-160	<b>13.50</b>	<b>17.50</b>	<b>17.50</b>

**128 Savana**



50  400

Boy/Renk	Krom/Siyah	Altın	Antik
160	12.50	16.00	16.00

**129 Buket**



40  320

Boy/Renk	Krom/Siyah	Altın	Antik
128-160	12.50	16.00	16.00

**130 Lale**



50  400

Boy/Renk	Krom/Siyah	Altın	Antik
160	10.00	13.75	13.75



## 131 Bakü

50  400

Boy/Renk	Krom	Altın/Antik	Siyah/Beyaz
128	9.50	11.10	9.80
160	11.50	13.50	11.90

## 132 Koray

75  600  
50  400

Boy/Renk	Krom/Siyah	Altın/Füme	Antik
96	9.00	10.00	10.00
128	12.00	13.00	13.00

## 133 Ayda

75  600

Boy/Renk	Krom/Siyah	Altın	Antik
96	7.00	8.25	8.25
128	8.60	9.80	9.80

## 134 Vera

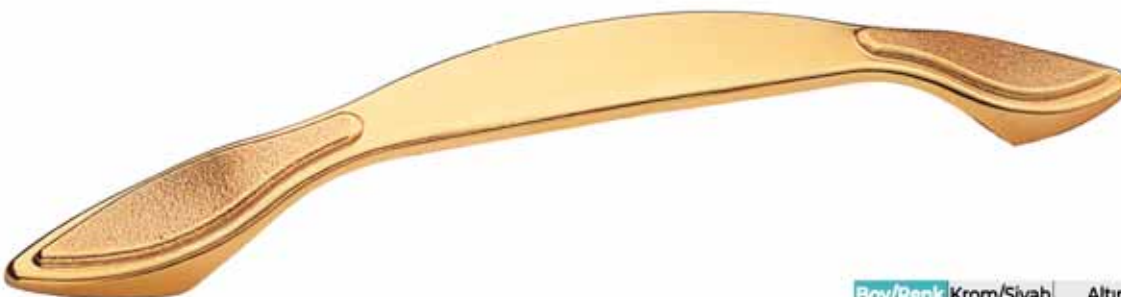
100  800

Boy/Renk	Krom/Siyah	Altın	Antik
96	5.20	6.50	5.80
128	6.50	7.60	6.00



**135** Parga



75  600

Boy/Renk	Krom/Siyah	Altın/Füme	Antik
96	10.50	12.00	12.00
128	14.50	15.50	15.50

**136** Ortaköy



75  600

Boy/Renk	Krom/Siyah	Altın	Antik
96	9.20	11.00	9.20
128	10.50	12.00	10.50
160	11.50	13.50	11.50
160	11.50	13.50	11.50

**137** Yayla



100 800  
75  600  
50 400

Boy/Renk	Krom/Siyah	Altın/Füme	Antik
Düğme	3.25	3.50	3.50
96	11.00	13.00	13.00
128	14.50	15.50	15.50

**138** Esenli



75  600

Boy/Renk	Krom/Siyah	Altın	Antik
Düğme	8.20	8.80	8.80
128	7.80	8.70	8.70

## 139 Umay



Boy/Renk	Krom/Antik	Altın	Füme
Düğme	4.40	5.30	5.30
160	12.40	14.00	14.00

50  400

## 140 Kayra



Boy/Renk	Krom	Antik	Altın/Füme
160	10.00	12.00	13.70

50  400

## 141 Mergen

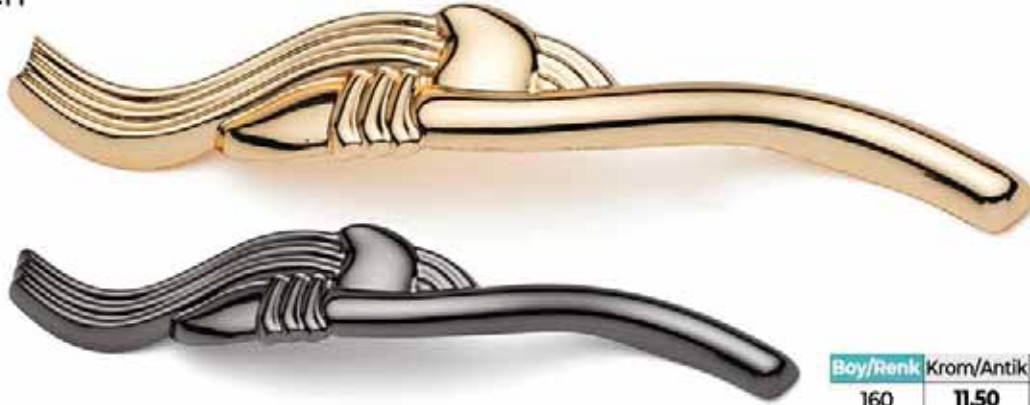

Boy/Renk	Krom/Antik	Altın	Füme
160	11.50	13.70	13.70

75  600

## 142 Suyla



Boy/Renk	Krom/Antik	Altın	Füme
160	12.00	13.70	13.70

40  320

**143** Pera



Boy/Renk	Krom/Inox	Siyah/Beyaz	Antik	Altın/Rose
96	13.60	13.60	14.30	16.20
128	15.75	15.75	16.45	18.90
160	17.45	17.45	18.60	20.90
224	21.45	21.45	22.90	26.50



### 144 Şehzade



Boy/Renk	Krom	Siyah/Beyaz	Antik	Altın/Rose
Düğme	6.45	6.45	7.15	7.45
96	12.45	12.45	14.30	15.35
128	16.30	16.30	18.30	19.45
160	17.60	17.60	20.60	21.05
224	21.05	21.05	24.20	26.05

### 145 Tomruk



Boy/Renk	Krom	Siyah/Beyaz	Antik	Altın/Rose
Düğme	6.45	6.45	7.15	7.45
96	12.30	12.30	13.75	14.90
128	15.75	15.75	17.45	18.90
160	17.20	17.20	19.35	20.60





**146 Han**

**147 Oba**



Boy/Renk	Krom	Siyah/Beyaz	Antik	Altın/Rose
128	12.30	12.30	14.05	15.45
160	14.05	14.05	15.75	17.45

Boy/Renk	Krom/Inox	Siyah/Beyaz	Antik	Altın/Rose
96	18.60	18.60	21.45	21.45
128	23.60	23.60	25.75	26.75
160	25.05	25.05	26.75	28.60

50  400

50  400

polimer ve porselen  
polymer and porcelain

### 148 Bileklik Taşlı



Renk/Boy	Düğme	160mm
Krom	15.60	31.20
Altın	16.25	33.80
Rose/Bronz	16.90	35.10

100 800  
50 400

### 148-A Bileklik



Renk/Boy	Düğme	160mm
Krom	14.30	26.00
Altın	15.60	27.30
Rose/Bronz	16.90	28.60

100 800  
50 400

### 149 Piramit



Renk/Boy	128mm	160mm
Krom/Siyah	11.90	12.90
Antik	11.90	12.90
Altın/Inox	13.90	15.40

50 400

### 149-A Köprü



Renk/Boy	128mm	160mm
Krom	14.90	15.90
Siyah/Antik	12.90	13.90
Altın	15.90	16.90

50 400



### 150 Manolya



Renk/Boy	160mm
Krom/Siyah	22.00
Altın	26.00
Antik	26.00

30  240

### 151 Manyas



Renk/Boy	Düğme	128-160
Krom/Siyah	5.50	22.00
Altın	6.50	26.00
Antik	5.50	26.00

75  600  
30  240

### 152 Verona



Renk/Boy	160mm
Krom/Siyah	25.00
Altın	28.50
Antik	28.50

25  200



**153** Venedik



Renk/Boy	Tekli	160mm
Krom/Siyah	5.50	10.80
Altın	6.50	13.40
Antik	5.50	13.40



75 600  
50 400

**154** Milano



Renk/Boy	160mm
Krom/Siyah	25.00
Altın	28.50
Antik	28.50

25 200

**155** Alpina



Renk/Boy	160mm
Krom/Siyah	20.00
Altın	24.00
Antik	24.00

40 320

### 156 Hera Porselen



Renk/Boy	96mm	128mm	128mm
Krom/Siyah	<b>11.80</b>	<b>15.20</b>	<b>16.50</b>
A.Sarı/A.Bakır	<b>12.90</b>	<b>16.50</b>	<b>17.70</b>
Altın	<b>14.20</b>	<b>17.40</b>	<b>18.80</b>

100  800  
50  400

### 157 Hera Polimer



Renk/Boy	96mm	128mm
Krom/Siyah	<b>8.50</b>	<b>12.70</b>
A.Sarı/A.Bakır	<b>9.30</b>	<b>12.70</b>
Altın	<b>11.50</b>	<b>14.50</b>

100  800  
50  400

### 158 Apollon Porselen



Renk/Boy	96mm	128mm	160mm
Krom/Siyah	<b>11.80</b>	<b>15.20</b>	<b>16.50</b>
A.Sarı/A.Bakır	<b>12.90</b>	<b>16.50</b>	<b>17.70</b>
Altın	<b>14.20</b>	<b>17.40</b>	<b>18.80</b>

100  800  
50  400

### 159 Apollon Polimer



Renk/Boy	96mm	128mm
Krom/Siyah	<b>8.50</b>	<b>12.70</b>
A.Sarı/A.Bakır	<b>9.30</b>	<b>12.70</b>
Altın	<b>11.50</b>	<b>14.50</b>

100  800  
50  400

**160** Freddo



Renk/Boy	96mm	128mm
Krom	21.85	28.35
Altın	25.25	31.85
Rose/Bronz	32.25	39.00

50 400

**161** Delta



Renk/Boy	160mm
Krom/Siyah	22.00
A.Sarı/A.Bakır	26.00
Altın	26.00

40 320

**162** Seçil



Renk/Boy	Düğme	128mm
Krom	4.20	6.80
A.Sarı/A.Bakır	4.20	6.80
Altın	6.20	9.20

50 400

**163** Artemis



Renk/Boy	96mm	128mm
Krom/Siyah/Byz	10.00	13.30
A.Sarı/A.BAkır	10.00	13.30
Altın/Füme	11.50	14.90

50 400



## 164 Gizem



Renk/Boy	Tekli	128
Krom	26.90	47.45
Altın/Füme	30.30	47.45
Inox	30.30	47.45

30  240

## 165 Melis



Renk/Boy	128
Krom	47.90
Altın/Füme	47.90
Inox	47.90

30  240

## 166 Fulya



Renk/Boy	128
Krom	51.85
Altın/Füme	51.85
Inox	51.85

30  240

## 167 Simge



Renk/Boy	128
Krom	46.60
Altın/Füme	46.60
Inox	46.60

30  240

168 Şah



Renk/Boy	96mm	128mm	160mm	192mm	224mm	256mm	288mm	320mm
Kr/Siyah/Beyaz	14.60	15.60	16.75	17.90	19.05	20.45	21.90	23.35
A.Sarı/A.Bakır	17.90	19.20	20.45	21.75	22.90	24.35	25.75	27.20
Altın	17.90	19.35	20.75	22.20	23.60	25.35	27.05	29.20



## 169 Lüks Roket Çizgili



Renk/Boy	128mm	160mm	192mm	224mm	256mm	320mm
Kr/Siyah/Beyaz	55.05	57.60	60.30	62.85	66.15	74.80
İnox	70.10	73.15	76.45	79.45	83.90	91.00
Altın/Fütme	70.10	73.15	76.45	79.50	83.90	91.00

30  240

## 170 Lizbon



Renk/Boy	96mm	128mm	160mm	192mm	224mm	256mm	288mm	320mm
Kr/Siyah/Beyaz	19.05	19.90	20.90	21.90	22.90	24.35	25.75	27.90
A.Sarı/A.Bakır	20.05	20.90	22.05	23.20	24.35	27.20	28.90	31.50
Altın	24.35	25.75	27.20	28.60	30.75	32.90	35.05	37.90

50  400

## 171 Beray Maya



Renk/Boy	128mm	160mm	192mm	224mm	256mm	288mm	320mm
Kr/Siyah/Beyaz	12.50	13.75	15.00	16.25	17.50	18.50	19.25
A.Sarı/A.Bakır	12.50	13.75	15.00	16.25	17.50	18.50	19.25
Altın	14.60	15.80	17.00	18.30	19.40	20.50	21.40

50  400

## 172 Beray Serdar Ayak



Renk/Boy	128mm	160mm	192mm	224mm	256mm	288mm	320mm
Kr/Siyah/Beyaz	14.30	15.20	16.20	17.20	18.20	19.35	20.75
A.Sarı/A.Bakır	17.60	18.90	19.90	20.90	21.90	22.90	24.60
Altın	17.20	18.30	19.35	20.35	21.45	22.60	24.05

50  400



**173** Beray Plato



Renk/Boy	128mm	160mm	192mm	224mm	256mm	288mm	320mm
Kr/Siyah/Beyaz	12.50	13.75	15.00	16.25	17.50	18.50	19.25
A.Sari/A.Bakır	14.60	15.80	17.00	18.30	19.40	20.50	21.50
Altın	14.60	15.80	17.00	18.30	19.40	20.50	21.50

40 320

**174** Beray Düz



Renk/Boy	96mm	128mm	160mm	192mm	224mm	256mm	288mm	320mm
Kr/Siyah/Beyaz	7.40	7.90	8.30	8.80	9.50	10.40	11.30	12.00
A.Sari/A.Bakır	7.70	8.10	8.50	9.00	10.00	10.70	11.60	12.30
Altın/Rose	8.20	8.50	9.00	9.50	10.50	11.50	12.50	13.50

50 400

**175** Beray Örümcek



Renk/Boy	96mm	128mm	160mm	192mm	224mm	256mm	288mm	320mm
Kr/Siyah/Beyaz	7.40	7.90	8.30	8.80	9.50	10.40	11.30	12.00
A.Sari/A.Bakır	7.70	8.10	8.50	9.00	10.00	10.70	11.60	12.30
Altın/Rose	8.20	8.50	9.00	9.50	10.50	11.50	12.50	13.50

50 400

**176** Beray İğne Ayak



Renk/Boy	96mm	128mm	160mm	192mm	224mm	256mm	288mm	320mm
Kr/Siyah/Beyaz	7.40	7.90	8.30	8.80	9.50	10.55	11.30	12.00
A.Sari/A.Bakır	7.70	8.10	8.50	9.00	10.00	10.70	11.60	12.30
Altın/Rose	8.20	8.50	9.00	9.50	10.50	11.50	12.50	13.50

50 400

### 177 Ottoman (Lüx)



Renk/Boy	96mm	128mm	160mm	192mm	224mm
Kr/Siyah/Beyaz	9.85	10.40	10.80	11.60	12.50
Altın	12.00	12.50	13.25	14.55	15.10
Rose/Bronz	10.80	11.45	12.10	13.00	13.80

50  400

### 178 Nur



Renk/Boy	96mm	128mm	160mm	192mm	224mm	256mm	288mm	320mm
Kr/Siyah/Beyaz	10.15	11.15	12.20	13.20	14.40	15.55	16.90	18.25
A.Sarı/A.Bakır	13.55	14.55	15.55	16.60	17.75	18.95	20.30	21.65
Altın/Rose	11.85	12.85	13.90	14.90	16.10	17.25	18.60	19.95

50  400

### 179 Sütun



Renk/Boy	128mm	160mm	224mm
Krom/Siyah	10.50	12.90	15.50
A.Sarı/A.Bakır	11.00	13.50	15.50
Altın/Füme	12.50	14.50	16.50

50  400

### 180 Eylül



Renk/Boy	96mm	128mm	160mm	192mm	224mm	256mm	288mm	320mm
Kr/Siyah/Beyaz	11.85	12.85	13.90	14.90	16.10	17.25	18.60	19.95
A.Sarı/A.Bakır	15.25	16.25	17.25	18.25	19.45	20.65	22.00	23.35
Altın/Rose	13.55	14.55	15.55	16.60	17.75	18.95	20.30	21.65

50  400

### 181 Plato Boncuk Polimer



Renk/Boy	128mm	160mm	192mm
Krom/Siyah	16.25	18.00	20.00
A.Sarı/A.Bakır	16.25	18.00	20.00
Altın	20.00	21.50	23.50

50 400

### 182 Düz Boncuk Polimer



Renk/Boy	96mm	128mm	160mm
Krom/Siyah	9.30	11.80	14.50
A.Sarı/A.Bakır	9.30	11.80	14.50
Altın	12.30	14.50	17.80

50 400

### 183 Örümcek Boncuk Polimer



Renk/Boy	96mm	128mm	160mm
Krom/Siyah	9.30	11.80	14.50
A.Sarı/A.Bakır	9.30	11.80	14.50
Altın	12.30	14.50	17.80

50 400

### 184 İğne Ayak Boncuk Polimer



Renk/Boy	64mm	96mm	128mm
Krom/Siyah	9.30	11.80	14.50
A.Sarı/A.Bakır	9.30	11.80	14.50
Altın	12.30	14.50	17.80

50 400



### 185 Plato Polimer



Renk/Boy	128mm	160mm	192mm
Krom/Siyah	10.00	11.00	12.50
A.Sarı/A.Bakır	10.00	11.00	12.50
Altın	11.00	12.50	13.75

50  400

### 186 Düz Polimer



Renk/Boy	Düğme	96mm	128mm	160mm
Krom/Siyah	5.30	6.30	7.00	8.00
A.Sarı/A.Bakır	5.30	6.30	7.00	8.00
Altın	6.00	7.60	8.30	9.30

50  400

### 187 Örümcek Polimer



Renk/Boy	Düğme	96mm	128mm	160mm
Krom/Siyah	5.30	6.30	7.00	8.00
A.Sarı/A.Bakır	5.30	6.30	7.00	8.00
Altın	6.00	7.60	8.30	9.30

100  800  
50  400

### 188 İğne Ayak Polimer



Renk/Boy	96mm	128mm
Krom/Siyah	7.90	9.00
A.Sarı/A.Bakır	7.90	9.00
Altın	8.90	10.00

50  400

### 189 Nur Boğumlu Polimer



Renk/Boy	128mm	160mm
Krom/Siyah	10.50	11.50
A.Sarı/A.Bakır	10.50	11.50
Altın	11.50	12.55

50 400

### 190 Nur Polimer



Renk/Boy	96mm	128mm	160mm
Krom/Siyah	9.80	10.80	11.90
A.Sarı/A.Bakır	9.80	10.80	11.90
Altın	10.50	11.50	12.50

50 400

### 191 Eylül Boğumlu Polimer



Renk/Boy	128mm	160mm
Krom/Siyah	13.90	15.55
A.Sarı/A.Bakır	13.90	15.55
Altın	14.90	16.60

50 400

### 192 Eylül Polimer



Renk/Boy	96mm	128mm	160mm
Krom/Siyah	11.85	12.70	13.55
A.Sarı/A.Bakır	11.85	12.70	13.55
Altın	12.85	13.70	14.55

50 400

### 193 Plato Boğumlu Polimer



Renk/Boy	160mm	192mm
Krom/Siyah	11.00	12.50
A.Sarı/A.Bakır	11.00	12.50
Altın	12.50	13.75

50  400

### 194 Düz Boğumlu Polimer



Renk/Boy	128mm	160mm
Krom/Siyah	8.30	9.50
A.Sarı/A.Bakır	8.30	9.50
Altın	9.20	10.50

50  400

### 195 Örümcek Boğumlu Polimer



Renk/Boy	128mm	160mm
Krom/Siyah	8.30	9.50
A.Sarı/A.Bakır	8.30	9.50
Altın	9.20	10.50

50  400

### 196 İğne Ayak Boğumlu Polimer



Renk/Boy	96mm	128mm
Krom/Siyah	8.30	9.50
A.Sarı/A.Bakır	8.30	9.50
Altın	9.20	10.50

50  400



### 197 Plato Porselen



Renk/Boy	128mm	160mm	192mm
Krom/Siyah	12.50	14.25	16.00
A.Sarı/A.Bakır	12.50	14.25	16.00
Altın	13.50	15.50	17.50

50 400

### 198 Düz Porselen



Renk/Boy	Düğme	96mm	128mm	160mm
Krom/Siyah	7.50	9.40	9.90	10.90
A.Sarı/A.Bakır	7.50	9.40	9.90	10.90
Altın	8.30	10.40	10.80	12.20

50 400

### 199 Örümcek Porselen



Renk/Boy	Düğme	96mm	128mm	160mm
Krom/Siyah	7.30	9.40	9.90	10.90
A.Sarı/A.Bakır	7.30	9.40	9.90	10.90
Altın	8.40	10.40	10.80	12.20

50 400

### 200 İğne Ayak Porselen



Renk/Boy	Düğme	64mm	96mm	128mm
Krom/Siyah	7.30	9.40	11.50	14.40
A.Sarı/A.Bakır	7.30	9.40	11.50	14.40
Altın	8.40	10.40	12.40	15.50

50 400

## 201 Nur Boğumlu Porselen

50  400

Renk/Boy	128mm	160mm
Krom/Siyah	17.25	18.95
A.Sarı/A.Bakır	17.25	18.95
Altın	18.25	19.95

## 202 Nur Porselen

50  400

Renk/Boy	96mm	128mm	160mm
Krom/Siyah	13.90	14.55	17.60
A.Sarı/A.Bakır	13.90	14.55	17.60
Altın	15.25	15.55	18.95

## 203 Eylül Boğumlu Porselen

50  400

Renk/Boy	128mm	160mm
Krom/Siyah	17.25	18.95
A.Sarı/A.Bakır	17.25	18.95
Altın	18.25	19.95

## 204 Eylül Porselen

50  400

Renk/Boy	96mm	128mm	160mm
Krom/Siyah	15.90	17.75	19.30
A.Sarı/A.Bakır	15.90	17.75	19.30
Altın	16.90	18.60	20.30

## 205 Plato Boğumlu Porselen



Renk/Boy	160mm	192mm
Krom/Siyah	15.00	17.50
A.Sarı/A.Bakır	15.00	17.50
Altın	16.00	18.00

50 400

## 206 Düz Boğumlu Porselen



Renk/Boy	128mm	160mm
Krom/Siyah	16.25	17.55
A.Sarı/A.Bakır	16.25	17.55
Altın	18.85	20.15

50 400

## 207 Örümcek Boğumlu Porselen



Renk/Boy	128mm	160mm
Krom/Siyah	16.25	17.55
A.Sarı/A.Bakır	16.25	17.55
Altın	18.85	20.15

50 400

## 208 İğne Ayak Boğumlu Porselen



Renk/Boy	128mm	160mm
Krom/Siyah	16.25	17.55
A.Sarı/A.Bakır	16.25	17.55
Altın	18.85	20.15

50 400



### 209 Sena İğne Ayak

50  400

Renk/Boy	64mm	96mm
Krom/Siyah	10.50	11.75
A.Sarı/A.Bakır	10.50	11.75
Altın	11.25	12.50

### 210 Sena İğne Ayak Boğumlu

50  400

Renk/Boy	64mm	96mm
Krom/Siyah	10.50	11.75
A.Sarı/A.Bakır	10.50	11.75
Altın	11.25	12.50

### 211 Sena Örümcek Ayak

50  400

Renk/Boy	64mm	96mm
Krom/Siyah	10.50	11.75
A.Sarı/A.Bakır	10.50	11.75
Altın	11.25	12.50

### 212 Sena Örümcek Ayak Boğumlu

50  400

Renk/Boy	64mm	96mm
Krom/Siyah	10.50	11.75
A.Sarı/A.Bakır	10.50	11.75
Altın	11.25	12.50

### 213 Sena Plato



50 400

Renk/Boy	128mm	160mm
Krom/Siyah	12.50	13.75
A.Sarı/A.Bakır	12.50	13.75
Altın	13.75	15.00



### 214 Sena Plato Boğumlu



50 400

Renk/Boy	128mm	160mm
Krom/Siyah	12.50	13.75
A.Sarı/A.Bakır	12.50	13.75
Altın	13.75	15.00



### 215 Sena Maya



50 400

Renk/Boy	128mm	160mm
Krom/Siyah	12.50	13.75
A.Sarı/A.Bakır	12.50	13.75
Altın	13.75	15.00



### 216 Sena Maya Boğumlu



50 400

Renk/Boy	128mm	160mm
Krom/Siyah	12.50	13.75
A.Sarı/A.Bakır	12.50	13.75
Altın	13.75	15.00





## 217 Tenten (60x60)



Renk/Boy	32mm
Krom	12.40
Altın	17.45

50  400

## 218 Düz Çizgili Porselen



Renk/Boy	96mm	128mm
Krom/Siyah	10.40	11.70
A.Sarı/A.Bakır	10.40	11.70
Altın	11.70	13.00

50  400

## 219 Örümcek Çizgili Porselen



Renk/Boy	96mm	128mm
Krom/Siyah	10.40	11.70
A.Sarı/A.Bakır	10.40	11.70
Altın	11.70	13.00

50  400

## 220 İğne Ayak Çizgili Porselen



Renk/Boy	96mm	128mm
Krom/Siyah	10.40	11.70
A.Sarı/A.Bakır	10.40	11.70
Altın	11.70	13.00

50  400



**221 Selen**



100 400

Renk/Boy	Düğme	96mm	128mm
Krom/Antik	3.50	4.65	4.90
Altın	4.95	6.30	6.90



**222 Desen**



100 800  
50 400

Renk/Boy	Düğme	128mm
Krom	9.00	15.00
Altın	10.00	18.00
Rose/Bronz	10.80	19.00

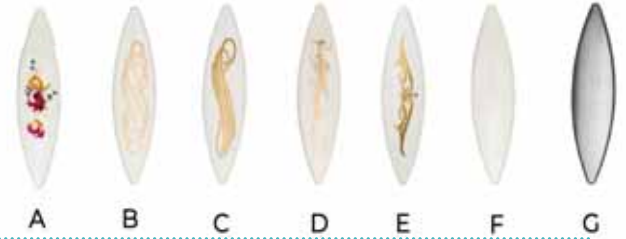

**223 Prizma**



50 400

Renk/Boy	128mm
Krom	7.80
Altın	16.00
Rose/Bronz	17.00

## Polimer Desen Kartelası

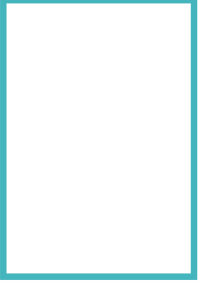

C-01



C-02



C-03



C-04



C-05



C-06



C-07



C-08



C-09



C-10

## Porselen Desen Kartelası

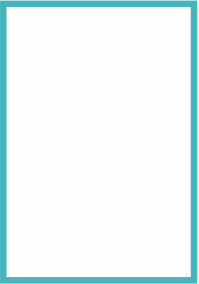

C-01



C-02



C-03



C-04



C-05\*



C-06\*



C-07\*



C-08\*



C-09\*



C-10\*

\*: Yıldızlı desenlerde net 0.50₺ fiyat farkı uygulanır.

kristaller  
crystals



**224 Eray**



Boy/Renk	Krom/Siyah	Altın
64	11.90	13.20
96	14.50	17.15
128	18.50	19.80

50 400

**225 Kutay**



Boy/Renk	Krom/Siyah	Altın
96	13.85	15.15

50 400

**226 Eray Küre Sarkaç**



Boy/Renk	Krom/Siyah	Altın
Sarkaç	10.55	11.90

50 400

**227 Kutay Küre Sarkaç**



Boy/Renk	Krom/Siyah	Altın
Sarkaç	10.55	11.90

50 400

**228 Eray Düğme**



Boy/Renk	Krom/Siyah	Altın
Düğme	10.55	11.90

50 400

**229 Kutay Düğme**



Boy/Renk	Krom/Siyah	Altın
Düğme	10.55	11.90

50 400

**230 Eray Sarkaç**



Boy/Renk	Krom/Siyah	Altın
Sarkaç	10.55	11.90

50 400

**231 Kutay Sarkaç**



Boy/Renk	Krom/Siyah	Altın
Sarkaç	10.55	11.90

50 400

**232 Gözde**



Boy/Renk	Krom/Siyah	Altın
96	10.00	10.20
128	10.00	11.40
160	11.60	12.00

50 400

**233 Yeni Gözde**



Boy/Renk	Krom/Siyah	Altın
96	31.00	37.00
128	37.00	41.00
160	51.00	55.00

**234 Kristal Küre**



Özel ayak seçeneği ile

Boy/Renk	Krom/Siyah	Altın
20mm	6.10	6.40
30mm	6.10	6.40
40mm	9.30	9.90

50 400

**235 Şeffaf Küre**



Özel ayak seçeneği ile

Boy/Renk	Krom/Siyah	Altın
Düğme	12.50	13.50

50 400

**236 Kristal Pimli**



Özel ayak seçeneği ile

Boy/Renk	Krom/Siyah	Altın
30mm	12.50	13.85
40mm	30.00	31.50

50 400

**237 Şeffaf Noktalı Küre**



Özel ayak seçeneği ile

Boy/Renk	Krom/Siyah	Altın
Düğme	19.80	20.50

50 400

**238 Kristal Kare**



Boy/Renk	Krom/Siyah	Altın
20mm	12.50	13.20
30mm	24.40	25.00

50 400

**239 Kristal Kupa**



Boy/Renk	Krom/Siyah	Altın
30mm	8.50	9.25
40mm	11.90	12.50

50 400

alüminyum  
aluminium



**240** Luce



Renk/Boy	128mm	160mm	192mm	224mm	256mm	288mm	320mm
Krom	34.85	36.40	39.00	40.30	42.90	44.85	46.80
Altın	40.30	41.60	45.50	46.80	49.40	52.00	54.60
Rose/Bronz	42.90	45.50	48.10	50.70	53.30	55.90	58.50

50 400

**241** Zen



Renk/Boy	128mm	160mm	192mm	224mm	256mm	288mm	320mm
Krom	17.30	19.25	21.35	23.40	25.35	27.30	29.40
Altın	21.60	24.20	26.80	29.15	31.75	34.20	30.95
Rose/Bronz	23.80	26.40	28.75	31.50	33.95	36.40	39.00

50 400

**242** MD2001 10cm
40  320

Renk/Boy	160mm	192mm	224mm	256mm	288mm	320mm
Krom/M.kr	16.00	17.20	18.20	19.30	20.45	21.50

**243** MD2001 12cm
40  320

Renk/Boy	160mm	192mm	224mm	256mm	288mm	320mm
Krom/M.kr	17.50	19.00	20.35	21.70	23.20	24.50

**244** Al. Oval Köprü
50  400

Renk/Boy	160mm	192mm	224mm	256mm	288mm	320mm
Krom/M.kr	22.00	25.50	29.00	32.00	36.00	39.00
Inox	25.50	29.00	32.00	36.00	39.00	42.00

**245** Al. Köşeli Köprü (7x25)
50  400

Renk/Boy	160mm	192mm	224mm	256mm	288mm	320mm
Krom/Siyah	33.50	38.00	42.25	46.50	50.70	54.95
Inox	35.50	39.50	44.00	48.25	52.40	56.60

**246** Al. Yeşilirmak Yay (7x25)



Renk/Boy	128mm	160mm	192mm	224mm	256mm	288mm	320mm
Krom/Siyah	10.35	12.40	14.30	15.90	17.45	19.05	22.20
Inox	12.70	14.95	17.00	18.60	20.00	21.10	27.00

50 400

**247** Al. Yeşilirmak (7x25)



Renk/Boy	128mm	160mm	192mm	224mm	256mm	288mm	320mm
Krom/Siyah	10.35	12.40	14.30	15.90	17.45	19.05	22.20
Inox	12.70	14.95	17.00	18.60	20.00	21.10	27.00

50 400

**248** Al. Botan (7x25)



Renk/Boy	128mm	160mm	192mm	224mm	256mm	288mm	320mm
Krom/Siyah	10.35	12.40	14.30	15.90	17.45	19.05	22.20
Inox	12.70	14.95	17.00	18.60	20.00	21.10	27.00

50 400

**249** Al. Lama (7x25)



Renk/Boy	128mm	160mm	192mm	224mm	256mm	288mm	320mm
Krom/Siyah	10.35	12.40	14.30	15.90	17.45	19.05	22.20
Inox	12.70	14.95	17.00	18.60	20.00	21.10	27.00

50 400



### 250 Al. Lüz Boğaziçi (8x16)



Renk/Boy	128mm	160mm	192mm	224mm	256mm	288mm	320mm
Krom	7.40	8.00	8.70	9.40	10.70	11.60	13.00
İnox/Siyah	7.80	8.70	9.20	9.70	11.00	12.00	13.40

50  400

### 251 Al. Kemer (8x16)



Renk/Boy	128mm	160mm	192mm	224mm	256mm	288mm	320mm
Krom	7.40	8.00	8.70	9.40	10.70	11.60	13.00
İnox/Siyah	7.80	8.70	9.20	9.70	11.00	12.00	13.40

50  400

### 252 Al. Botan (8x16)



Renk/Boy	128mm	160mm	192mm	224mm	256mm	288mm	320mm
Krom	7.40	8.00	8.70	9.40	10.70	11.60	13.00
İnox/Siyah	7.80	8.70	9.20	9.70	11.00	12.00	13.40

50  400

### 253 Al. U Botan (8x16)



Renk/Boy	128mm	160mm	192mm	224mm	256mm	288mm	320mm
Krom	7.40	8.00	8.70	9.40	10.70	11.60	13.00
İnox/Siyah	7.80	8.70	9.20	9.70	11.00	12.00	13.40

50  400

**254** Al. Akasya (8x16)



Renk/Boy	128mm	160mm	192mm	224mm	256mm	288mm	320mm
Krom	7.40	8.00	8.70	9.40	10.70	11.60	13.00
Inox/Siyah	7.80	8.70	9.20	9.70	11.00	12.00	13.40

50 400

**255** Al. U Akasya (8x16)



Renk/Boy	128mm	160mm	192mm	224mm	256mm	288mm	320mm
Krom	7.60	8.00	8.70	9.40	10.70	11.60	13.00
Inox/Siyah	7.80	8.70	9.20	9.70	11.00	12.00	13.40

50 400

**256** Al. L Profil (12x14)



Renk/Boy	96mm	128mm	160mm	192mm	224mm	256mm	288mm	320mm
Krom	6.00	6.60	7.30	7.80	8.50	9.60	10.50	11.50
Inox/Siyah	6.40	7.00	7.50	8.20	8.90	9.90	10.80	11.90

50 400

**257** Al. Ray (8x16)



Renk/Boy	96mm	128mm	160mm	192mm	224mm	256mm	288mm	320mm
Krom	6.00	7.40	8.30	9.60	11.00	12.40	13.80	15.40
M.Kr/Siyah	6.00	7.40	8.30	9.60	11.00	12.40	13.80	15.40

50 400

**258** Al. Kelkit Set (8x16)

Renk/Boy	128mm	160mm	192mm	224mm	256mm	288mm	320mm
Krom	7.40	8.00	8.70	9.40	10.70	11.60	13.00
Inox/Siyah	7.80	8.70	9.20	9.70	11.00	12.00	13.40

50  400
**259** Al. Kelkit Yay (8x16)

Renk/Boy	128mm	160mm	192mm	224mm	256mm	288mm	320mm
Krom	7.40	8.00	8.70	9.40	10.70	11.60	13.00
Inox/Siyah	7.80	8.70	9.20	9.70	11.00	12.00	13.40

50  400
**260** Al. Kelkit Klas (8x16)

Renk/Boy	128mm	160mm	192mm	224mm	256mm	288mm	320mm
Krom	7.40	8.00	8.70	9.40	10.70	11.60	13.00
Inox/Siyah	7.80	8.70	9.20	9.70	11.00	12.00	13.40

50  400
**261** Al. Kelkit U (8x16)

Renk/Boy	128mm	160mm	192mm	224mm	256mm	288mm	320mm
Krom	7.40	8.00	8.70	9.40	10.70	11.60	13.00
Inox/Siyah	7.80	8.70	9.20	9.70	11.00	12.00	13.40

50  400



**262** Al. Aybüke (8x12)



Renk/Boy	128mm	160mm	192mm	224mm	256mm	288mm	320mm
Krom	6.30	6.70	7.20	7.70	8.90	9.90	10.80
Inox/Siyah	6.70	7.10	7.50	8.00	9.30	10.30	11.20

50 400

**263** Al. Boğaziçi (8x12)



Renk/Boy	128mm	160mm	192mm	224mm	256mm	288mm	320mm
Krom	6.30	6.70	7.20	7.70	8.90	9.90	10.80
Inox/Siyah	6.70	7.10	7.50	8.00	9.30	10.30	11.20

50 400

**264** Al. Balabadi (8x12)



Renk/Boy	128mm	160mm	192mm	224mm	256mm	288mm	320mm
Krom	6.30	6.70	7.20	7.70	8.90	9.90	10.80
Inox/Siyah	6.70	7.10	7.50	8.00	9.30	10.30	11.20

50 400

**265** Al. Bolaman (8x12)



Renk/Boy	96mm	128mm	160mm	192mm	224mm	256mm	320mm
Krom/Siyah	10.00	12.50	14.65	17.00	19.40	21.90	26.90
Mat Krom	10.00	12.50	14.65	17.00	19.40	21.90	26.90

50 400

### 266 Al. Boru Şahin (8x18)



Renk/Boy	128mm	160mm	192mm	224mm	256mm	288mm	320mm
Krom	5.20	5.70	6.20	6.70	7.70	8.70	9.60
Inox/Siyah	5.60	6.00	6.60	7.00	8.00	9.00	9.90

50  400

### 267 Al. Boru Şahin Yay (8x18)



Renk/Boy	128mm	160mm	192mm	224mm	256mm	288mm	320mm
Krom	5.20	5.70	6.20	6.70	7.70	8.70	9.60
Inox/Siyah	5.60	6.00	6.60	7.00	8.00	9.00	9.90

50  400

### 268 Al. Boru Kumru (8x18)



Renk/Boy	128mm	160mm	192mm	224mm	256mm	288mm	320mm
Krom	5.20	5.70	6.20	6.70	7.70	8.70	9.60
Inox/Siyah	5.60	6.00	6.60	7.00	8.00	9.00	9.90

50  400

### 269 Al. Boru Kumru Yay (8x18)



Renk/Boy	128mm	160mm	192mm	224mm	256mm	288mm	320mm
Krom	5.20	5.70	6.20	6.70	7.70	8.70	9.60
Inox/Siyah	5.60	6.00	6.60	7.00	8.00	9.00	9.90

50  400

**270** Al. Şahin (8x18)



Renk/Boy	128mm	160mm	192mm	224mm	256mm	288mm	320mm
Krom	6.50	7.20	7.70	8.20	9.10	10.15	11.20
Inox/Siyah	7.00	7.60	7.10	8.60	9.50	10.55	11.55

50 400

**271** Al. Şahin Yay (8x18)

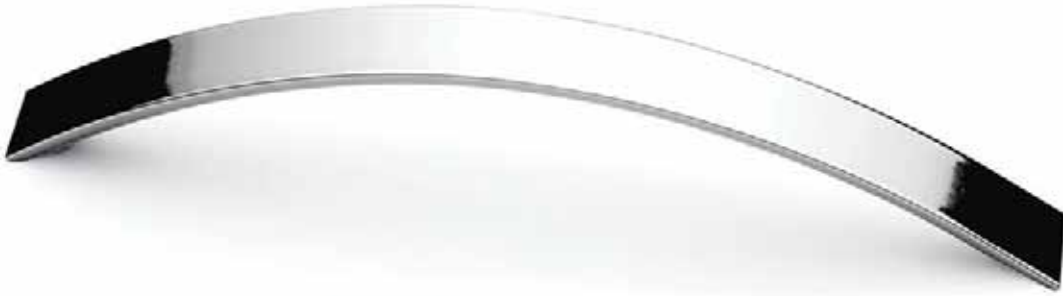

Renk/Boy	128mm	160mm	192mm	224mm	256mm	288mm	320mm
Krom	6.50	7.20	7.70	8.20	9.10	10.15	11.20
Inox/Siyah	7.00	7.60	8.10	8.60	9.50	10.55	11.55

50 400

**272** Al. Kumru (8x18)



Renk/Boy	128mm	160mm	192mm	224mm	256mm	288mm	320mm
Krom	6.50	7.20	7.70	8.20	9.10	10.15	11.20
Inox/Siyah	7.00	7.60	8.10	8.60	9.50	10.55	11.55

50 400

**273** Al. Kumru Yay (8x18)



Renk/Boy	128mm	160mm	192mm	224mm	256mm	288mm	320mm
Krom	6.50	7.20	7.70	8.20	9.10	10.15	11.20
Inox/Siyah	7.00	7.60	8.10	8.60	9.50	10.55	11.55

50 400

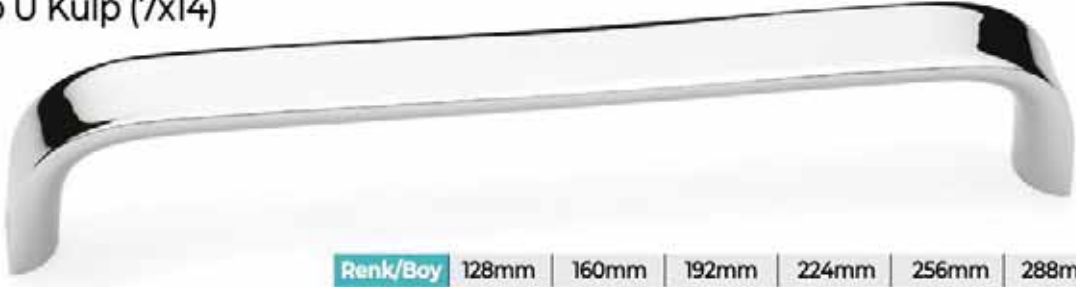

**274** Al. Eko U Kulp (7x14)

Renk/Boy	128mm	160mm	192mm	224mm	256mm	288mm	320mm
Krom	5.30	5.80	6.30	6.80	7.90	8.70	9.90
Inox/Siyah	5.70	6.10	6.70	7.20	8.20	9.00	10.20

50  400
**275** Al. Sude Mega (7x14)

Renk/Boy	128mm	160mm	192mm	224mm	256mm	288mm	320mm
Krom	5.30	5.80	6.30	6.80	7.90	8.70	9.90
Inox/Siyah	5.70	6.10	6.70	7.20	8.20	9.00	10.20

50  400
**276** Al. Eko Boğaziçi Yay (7x9)

Renk/Boy	128mm	160mm	192mm	224mm	256mm	288mm	320mm
Krom/Siyah	5.50	6.50	7.30	8.10	8.80	9.60	11.00
Inox	6.50	7.30	8.20	8.90	10.00	10.60	12.20

50  400
**277** Al. Eko Balabadi(7x9)

Renk/Boy	128mm	160mm	192mm	224mm	256mm	288mm	320mm
Krom/Siyah	5.50	6.50	7.30	8.10	8.80	9.60	11.00
Inox	6.50	7.30	8.20	8.90	10.00	10.60	12.20

50  400
**278** Al. Eko Boğaziçi (7x9)

Renk/Boy	128mm	160mm	192mm	224mm	256mm	288mm	320mm
Krom/Siyah	5.50	6.50	7.30	8.10	8.80	9.60	11.00
Inox	6.50	7.30	8.20	8.90	10.00	10.60	12.20

50  400

**279** Al. Eko Şahin (7x14)



Renk/Boy	128mm	160mm	192mm	224mm	256mm	288mm	320mm
Krom	5.30	5.80	6.30	6.80	7.90	8.70	9.90
Inox/Siyah	5.70	6.10	6.70	7.20	8.20	9.00	10.20

50 400

**280** Al. Eko Şahin Yay (7x14)



Renk/Boy	128mm	160mm	192mm	224mm	256mm	288mm	320mm
Krom	5.30	5.80	6.30	6.80	7.90	8.70	9.90
Inox/Siyah	5.70	6.10	6.70	7.20	8.20	9.00	10.20

50 400

**281** Al. Eko Kumru (7x14)



Renk/Boy	128mm	160mm	192mm	224mm	256mm	288mm	320mm
Krom	5.30	5.80	6.30	6.80	7.90	8.70	9.90
Inox/Siyah	5.70	6.10	6.70	7.20	8.20	9.00	10.20

50 400

**282** Al. Eko Kumru Yay (7x14)



Renk/Boy	128mm	160mm	192mm	224mm	256mm	288mm	320mm
Krom	5.30	5.80	6.30	6.80	7.90	8.70	9.90
Inox/Siyah	5.70	6.10	6.70	7.20	8.60	9.50	10.20

50 400

**283** Al. Eko Asya (7x14)



Renk/Boy	128mm	160mm	192mm	224mm	256mm	288mm	320mm
Krom	5.30	5.80	6.30	6.80	7.90	8.70	9.90
Inox/Siyah	5.70	6.10	6.70	7.20	8.60	9.50	10.20

50 400

### 284 Al. Geniş L Profil (20x23)

50  400

Renk/Boy	96mm	128mm	160mm	192mm	224mm	256mm	288mm	320mm
Krom	8.60	9.35	10.15	10.90	11.85	13.00	14.30	15.60
Inox/Siyah	8.95	9.75	10.55	11.30	12.20	13.40	14.70	16.00

### 285 Al. Zara (16x22)

50  400

Renk/Boy	96mm	128mm	160mm	192mm	224mm	256mm	288mm	320mm
Krom	9.10	9.90	10.65	11.45	12.35	13.65	14.95	16.25
Inox/Siyah	9.50	10.25	11.05	11.85	12.75	14.05	15.35	16.65

### 286 Al. Delta (24x24)

50  400

Renk/Boy	96mm	128mm	160mm	192mm	224mm	256mm	288mm	320mm
Krom	9.55	11.10	12.70	14.30	15.90	17.45	19.05	19.05
Inox/Siyah	11.60	13.20	15.40	16.50	18.25	19.85	22.20	25.40

### 287 Al. Dörtgen Boy

50  400

Renk/Boy	128mm	160mm	192mm	224mm	256mm	288mm	320mm
Krom	14.00	15.50	17.00	18.50	20.00	21.50	23.00
Inox	15.50	17.00	18.50	20.00	21.50	23.00	24.50



**288** Al. Boy Ø12



Renk/Boy	96mm	128mm	160mm	192mm	224mm	256mm	288mm	320mm
Krom	11.00	11.85	12.65	13.80	15.00	16.40	17.95	19.25
Inox	11.00	11.85	12.65	13.80	15.00	16.40	17.95	19.25

50 400

**289** Al. Kartal



Renk/Boy	96mm	128mm	160mm	192mm	224mm	256mm	288mm	320mm
Kr/M.Krom	7.30	8.25	9.25	10.40	11.40	12.50	13.50	14.50

50 400

**290** Al. Kare Boru Düz



Renk/Boy	96mm	128mm	160mm	192mm	224mm	256mm	288mm	320mm
Kr/M.Krom	8.20	9.00	9.90	10.80	11.80	12.80	13.80	14.80
Kr/Inox	8.20	9.00	9.90	10.80	11.80	12.80	13.80	14.80

50 400

**291** Al. Kare Boru Çizgili



Renk/Boy	96mm	128mm	160mm	192mm	224mm	256mm	288mm	320mm
Kr/M.Krom	8.20	9.00	9.90	10.80	11.80	12.80	13.80	14.80
Kr/Inox	8.20	9.00	9.90	10.80	11.80	12.80	13.80	14.80

50 400

### 292 Al. Yassam Gömme

50  400

Renk/Boy	64mm	96mm	128mm	160mm	192mm	224mm	256mm	288mm	320mm
Krom/M.Krom	8.40	9.10	10.00	11.20	12.60	13.50	14.70	16.00	17.50

### 293 Al. Yeni Gömme

50  400

Renk/Boy	64mm	96mm	128mm	160mm	192mm	224mm	256mm	288mm	320mm
Krom/M.Krom	6.50	7.30	8.00	8.80	9.70	10.50	11.50	12.20	13.80

### 294 Al. Boru

50  400

Renk/Boy	96mm	128mm	160mm	192mm	224mm	256mm	288mm	320mm
Krom/M.Krom	6.45	7.10	7.80	8.45	9.15	9.80	10.50	11.20

### 295 Al. Çizgili

50  400

Renk/Boy	96mm	128mm	160mm	192mm	224mm	256mm	288mm	320mm
Krom/M.Krom	6.50	7.50	8.55	9.50	10.75	11.70	12.75	13.85

lüks  
luxury



## 296 Lüks Roket



## 297 Lüks Küre



## 298 Lüks Pompe



## 299 Lüks Sarnıç



Renk/Boy	128mm	160mm	192mm	224mm	256mm	320mm
Krom	51.65	54.05	56.55	59.00	62.05	70.20
İnox	65.80	68.65	71.75	74.55	78.75	85.40
Altın	65.80	68.65	71.75	74.60	78.75	85.40
Füme	65.80	68.65	71.75	74.60	78.75	85.40

### 300 Aybastı



Renk/Boy	128	160	224	320
Krom	27.35	36.15	41.75	62.35
İnox	37.70	45.15	49.30	89.30
Altın/Füme	37.70	45.15	49.30	89.30

40 320  
30 240  
20 160  
20 160

### 301 Dalga



Renk/Boy	128	192
Krom	32.10	35.40
İnox	39.45	44.55
Altın/Füme	39.45	44.55

50 400  
30 240

### 302 Tuna

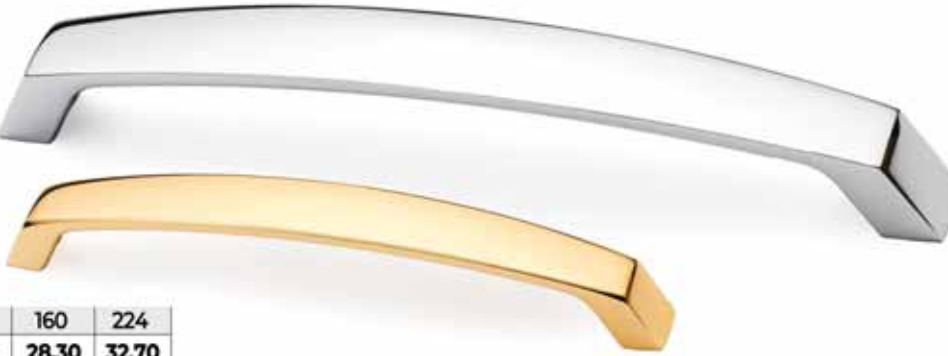

Renk/Boy	128	160	224
Krom	26.35	28.30	32.70
İnox	32.25	35.40	41.85
Altın/Füme	32.25	35.40	41.85

50 400  
50 400  
30 240

### 303 Mekik



Renk/Boy	128	160	224
Krom	25.25	27.35	32.10
İnox	32.10	35.50	42.00
Altın/Füme	32.10	35.50	42.00

50 400  
40 320  
30 240

## 304 Bedir



Renk/Boy	128	160	224
Krom	27.45	30.15	35.75
İnox	33.55	38.85	48.60
Altın/Füme	33.55	38.85	48.60

50 400  
30 240  
25 200

## 305 Toros



Renk/Boy	128	160	224	256
Krom	27.10	29.55	33.10	46.60
İnox	33.20	37.35	42.35	56.45
Altın/Füme	33.20	37.35	42.35	56.45

50 400  
40 320  
30 240  
30 240

## 306 Boğaziçi (M.Sinan)

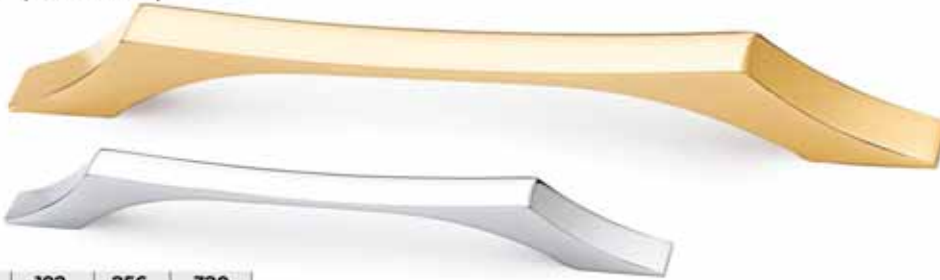

Renk/Boy	128	192	256	320
Krom	28.10	32.35	46.60	61.65
İnox	34.40	42.25	56.40	76.90
Altın/Füme	34.40	42.25	56.40	76.90

40 320  
30 240  
20 160  
20 160

## 307 Kobra



Renk/Boy	128	160	224	256
Krom	28.10	30.15	33.80	46.85
İnox	34.40	39.80	46.85	54.20
Altın/Füme	34.40	39.80	46.85	54.20

50 400  
30 240  
25 200  
25 200



**308** Vezir



Renk/Boy	96	128	160	192	224	256	320
Krom	25.55	27.30	29.45	30.20	30.80	44.85	50.50
İnox	32.55	33.25	34.65	36.05	37.25	49.65	59.00
Altın/Füme	37.70	39.90	40.85	42.95	43.80	55.25	66.50

50 400  
40 320  
40 320  
30 240

**309** Yeni Kare



Renk/Boy	128	160	192	224
Krom	16.05	17.50	24.30	21.50
İnox	17.80	18.40	20.05	27.15
Altın/Füme	20.05	22.10	21.95	27.85

50 400  
40 320  
30 240  
30 240

**310** Yıldız



Renk/Boy	160	224
Krom	32.55	39.55
İnox	37.10	46.45
Altın/Füme	41.20	48.20

40 320  
30 240

**311** Kamer



Renk/Boy	128	160	224
Krom	23.55	25.25	33.80
İnox	31.15	32.60	43.35
Altın/Füme	31.15	32.60	43.35

40 320  
30 240  
30 240

### 312 Duygu



Renk/Boy	160	192	224
Krom	28.80	36.40	40.05
İnox	35.15	41.25	45.40
Altın/Füme	45.90	48.10	57.60

30  240

### 313 Derya



Renk/Boy	160	192
Krom	33.70	36.40
İnox	38.80	43.10
Altın/Füme	56.40	60.20

30  240

### 314 Buket



Renk/Boy	96
Krom	26.35
İnox	31.05
Altın/Füme	31.05

40  320

### 315 Taç



Renk/Boy	96
Krom	26.35
İnox	31.05
Altın/Füme	31.05

40  320

### 316 Denizatı



Renk/Boy	160	192
Krom	29.10	33.25
İnox	37.00	40.05
Altın/Füme	40.15	49.65

50 400

### 317 İkbal



Renk/Boy	128	160	224	256	320
Krom	25.95	28.15	29.55	39.45	46.05
İnox	31.00	34.70	36.40	45.25	50.75
Altın/Füme	31.00	34.70	36.40	45.25	50.75

50 400  
40 320  
30 240

### 318 14mm Paslanmaz Boru



Fiyat Alınız.

Renk/Boy	96mm	128mm	160mm	192mm	224mm	256mm	288mm	320mm
Krom/İnox								
İnox								

50 400

### 319 16mm Paslanmaz Boru



Fiyat Alınız.

Renk/Boy	96mm	128mm	160mm	192mm	224mm	256mm	288mm	320mm
Krom/İnox								
İnox								

50 400



folyolu  
folios

**320** Al. Atlas



Renk/Boy	160	224	320
Krom	19.05	27.00	34.90
Altın	23.80	31.75	39.65

50 400

**321** Al. Hitit

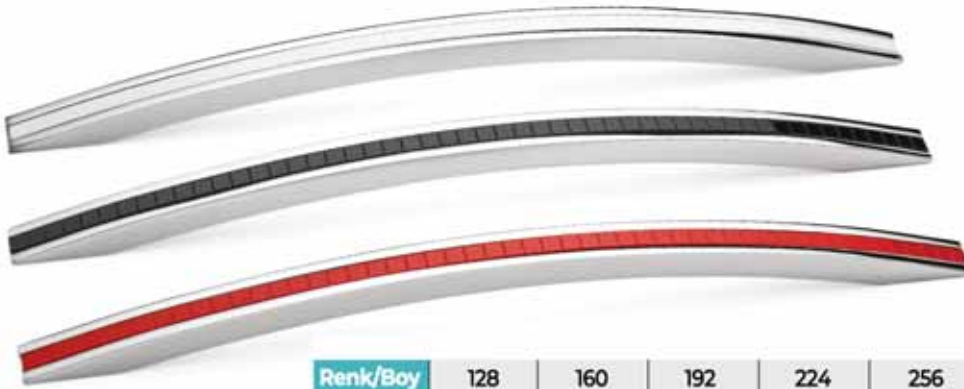

Renk/Boy	128	160	192	224	256	288	320
Krom	9.40	11.10	13.20	14.95	16.65	19.05	20.65

50 400

**322** Al. Sümer

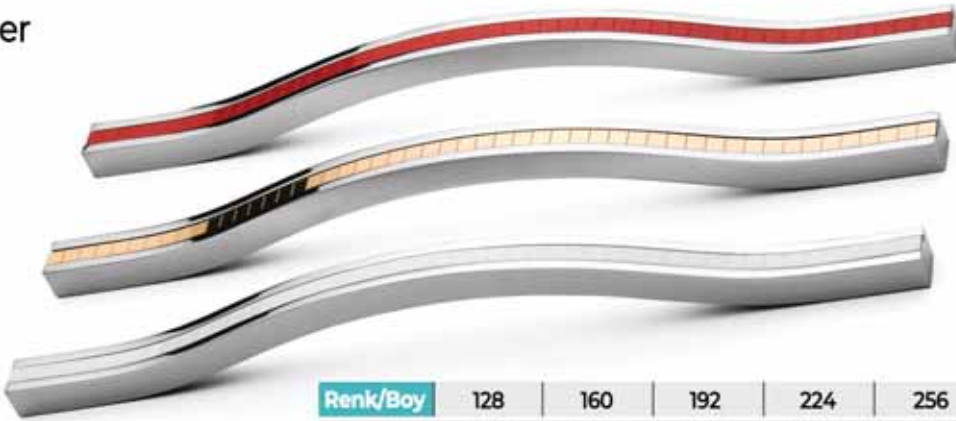

Renk/Boy	128	160	192	224	256	288	320
Krom	9.40	11.10	13.20	14.95	16.65	19.05	20.65

50 400

**323** Al. Efes



Renk/Boy	128	160	192	224	256	288	320
Krom	7.20	8.55	10.15	11.50	12.85	14.65	15.90

50 400

### 324 Manolya Folyolu

50  400

Renk/Boy	Düğme	128	160	224
Krom	8.50	8.50	10.00	13.50

### 325 Çift Sıra Folyolu

50  400

Renk/Boy	128	160	224
Krom	8.50	10.00	13.50

### 326 Nil Folyolu

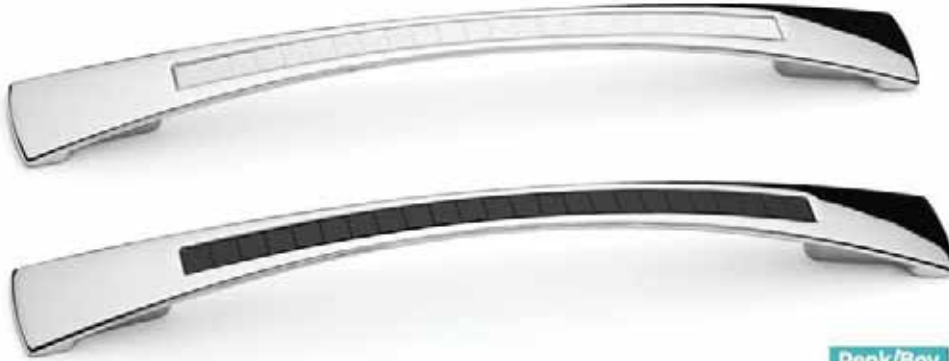
50  400

Renk/Boy	96	128	160
Krom	6.90	7.90	10.10

### 327 Yalı Şeritli

50  400

Renk/Boy	128	160	224
Krom	10.95	12.75	16.40



zamak  
zinc

**328** Roma

Renk/Boy	128	160	224
Krom/Siyah	<b>15.75</b>	<b>17.90</b>	<b>22.20</b>
Inox/Antik	<b>17.20</b>	<b>19.35</b>	<b>23.60</b>
Altın/Rose	<b>18.60</b>	<b>21.20</b>	<b>27.30</b>

**329 Pisa**



Renk/Boy	128	160	224
Krom/Siyah	16.60	19.45	25.20
Inox/Antik	18.05	20.90	26.60
Altın/Rose	19.45	22.75	30.05

50  400

**330 Milano**



Renk/Boy	128	160	224
Krom/Siyah	15.75	17.90	25.05
Inox/Antik	17.20	19.35	26.50
Altın/Rose	19.45	21.20	30.05

50  400



### 331 Lancia



Renk/Boy	64	96
Krom/Siyah	13.65	20.30
Altın	14.95	22.10
Rose/Bronz	16.25	23.40

50  400

### 332 Forbici



Renk/Boy	160	224
Krom/Siyah	23.40	28.60
Altın	27.30	31.20
Rose/Bronz	28.60	32.50

50  400

### 333 Fibono



Renk/Boy	160	224	320
Krom/Siyah	17.55	20.80	26.00
Altın	20.80	24.70	29.90
Rose/Bronz	22.10	26.00	31.20

50  400

### 334 Favori



Renk/Boy	160-192	224-256
Krom/Siyah	20.80	27.30
Altın	23.40	31.20
Rose/Bronz	26.00	32.50

50  400

### 335 Almira



Renk/Boy	96	160-224
Krom/Siyah	21.00	28.50
Altın	24.00	31.00
Rose/Bronz	26.00	32.50

50  400

### 336 Cozze



Renk/Boy	64	96
Krom/Siyah	20.50	24.00
Altın	22.50	26.50
Rose/Bronz	25.00	28.00

50  400

### 337 Elika



Renk/Boy	32
Krom/Siyah	37.50
Altın	40.00
Rose/Bronz	42.50

30  400

### 338 Passo



Renk/Boy	160
Krom/Siyah	27.50
Altın	30.00
Rose/Bronz	31.50

50  400

### 339 Positano



Renk/Boy	160
Krom	<b>18.00</b>
Altın	<b>19.90</b>
Rose/Bronz	<b>22.90</b>

50  400

### 340 Floransa



Renk/Boy	128	160
Krom	<b>17.90</b>	<b>19.90</b>
Altın	<b>19.90</b>	<b>20.90</b>
Rose/Bronz	<b>21.90</b>	<b>22.90</b>

50  400

### 341 Mekik Kumlu



Renk/Boy	160	224
Krom	<b>20.00</b>	<b>25.00</b>
Altın	<b>22.50</b>	<b>29.00</b>
Rose/Bronz	<b>25.00</b>	<b>30.00</b>

50  400

### 342 Mekik Düz



Renk/Boy	160	224
Krom	<b>20.00</b>	<b>25.00</b>
Altın	<b>22.50</b>	<b>29.00</b>
Rose/Bronz	<b>25.00</b>	<b>30.00</b>

50  400



**343 Floksi**



Renk/Boy	160	224
Krom/Siyah	20.80	28.60
Altın	26.00	31.20
Rose/Bronz	23.40	33.15

50 400

**344 Labirent**



Renk/Boy	64
Krom/Siyah	16.50
Inox	16.50
Altın	18.50

40 400

**345 Rüzgar**



Renk/Boy	64
Krom/Siyah	16.50
A.Sarı/A.Bakır	16.50
Altın/Rose	18.50

75 400

**346 Yonca**



Renk/Boy	128	160	192	224
Krom/Siyah	5.85	9.10	10.40	13.65
Inox	6.50	9.90	11.20	14.30
Altın	7.80	11.70	13.00	16.90
Mat Altın	8.45	13.00	14.30	19.50

75 400

## 347 Zebra



Renk/Boy	128
Krom/Siyah	17.70
Altın	20.80
Rose/Bronz	22.10

50  400

## 348 Vento



Renk/Boy	160
Krom/Siyah	19.50
Altın	22.10
Rose/Bronz	23.40

50  400

## 349 Omega



Renk/Boy	32	128
Krom/Siyah	9.10	21.45
Altın	9.90	23.40
Rose/Bronz	10.95	24.70

50  400

## 350 Hilal



Renk/Boy	32	96
Krom/Siyah	7.15	16.90
Altın	9.75	18.75
Rose/Bronz	10.75	20.15

50  400

### 351 Tas Kulp Motifli



Renk/Boy	64	96
Krom/Siyah	7.50	9.00
Antik	7.50	9.00
Altın	8.00	10.00

50 400

### 352 Tas Kulp



Renk/Boy	64	96
Krom/Siyah	7.85	9.50
Antik	8.55	10.00
Altın	10.75	12.00

75 600  
50 400

### 353 Eko Kale



Renk/Boy	128	160	192
Krom/Siyah	6.40	7.25	8.3
Inox	7.20	8.05	9.50
Altın	8.05	9.50	11.20

50 400

### 354 İrem



Renk/Boy	64	96	128
Krom/Siyah	9.40	11.70	16.80
Altın/Füme	12.30	15.00	20.80
Rose/Bronz	12.30	15.00	20.80

50 400

### 355 Asma



Renk/Boy	96	128	160
Krom/Siyah	6.50	9.75	13.35
Altın	10.10	14.05	18.40

50 400  
50 400  
30 240



### 356 Krizantem



Renk/Boy	96	128
Krom/Siyah	9.75	11.60
Antik	10.75	12.90
Altın/Rose	11.90	14.05

50  400

### 357 Azelya



Renk/Boy	96	128	160
Krom/Siyah	9.30	12.30	14.30
Antik	10.30	13.20	14.30
Altın/Rose	11.45	13.45	16.60

50  400

### 358 Fulya



Renk/Boy	96	128
Krom/Siyah	8.30	11.15
Antik	9.30	12.20
Altın/Rose	10.45	13.60

50  400

### 359 Sardunya



Renk/Boy	96	128
Krom/Siyah	9.05	10.90
Antik	10.05	11.75
Altın/Rose	11.15	13.30

50  400

**360** Başak



Renk/Boy	96	128	160
Krom	4.75	5.50	9.00
Altın	8.25	9.25	12.00

50 400

**361** Başak PVC



Renk/Boy	96	128	160
Krom	8.25	9.75	13.75
Altın	9.75	11.25	16.25

50 400

**362** Defne



Renk/Boy	128	160
Krom	8.75	11.75
Altın	11.25	13.75

50 400

**363** Defne PVC



Renk/Boy	128	160
Krom	9.50	11.75
Altın	11.25	15.00

50 400

### 364 Hande



Renk/Boy	160	192	224
Krom/Siyah	10.85	13.20	15.65
Antik	10.85	13.20	15.65
Altın/Füme	12.85	15.55	18.60

50  400

### 365 Pelin



Renk/Boy	128-160	192-224
Krom/Siyah	11.85	15.55
Antik	11.85	15.55
Altın/Füme	14.20	18.60

50  400

### 366 Elif



Renk/Boy	160	224
Krom/Siyah	12.70	13.70
Antik	12.70	13.70
Altın/Füme	14.70	16.25

50  400

### 367 D Kulp



Renk/Boy	192	224	256
Krom/Siyah	11.45	12.70	19.95
Antik	11.45	12.70	19.95
Altın/Füme	13.95	15.25	22.85

50  400



**368 Kale**

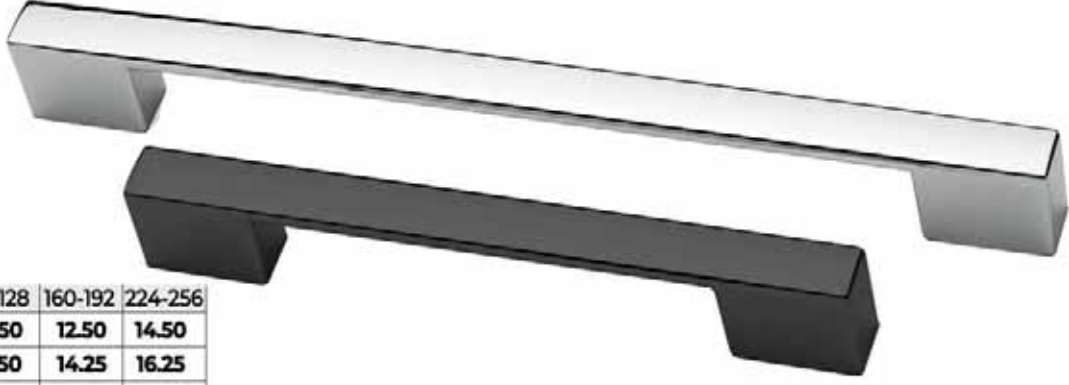

Renk/Boy	96-128	160-192	224-256
Krom/Siyah	10.50	12.50	14.50
Inox	12.50	14.25	16.25
Altın	13.75	15.50	16.50
A.Sarı/A.Bakır	13.75	15.50	16.50

50 400  
40 320  
40 320

**369 Simav**



Renk/Boy	96-128	160-192	224-256
Krom/Siyah	10.50	12.50	14.50
Altın	13.75	15.50	16.50
A.Sarı/A.Bakır	13.75	15.50	16.50

50 400  
40 320  
40 320

**370 İtir**

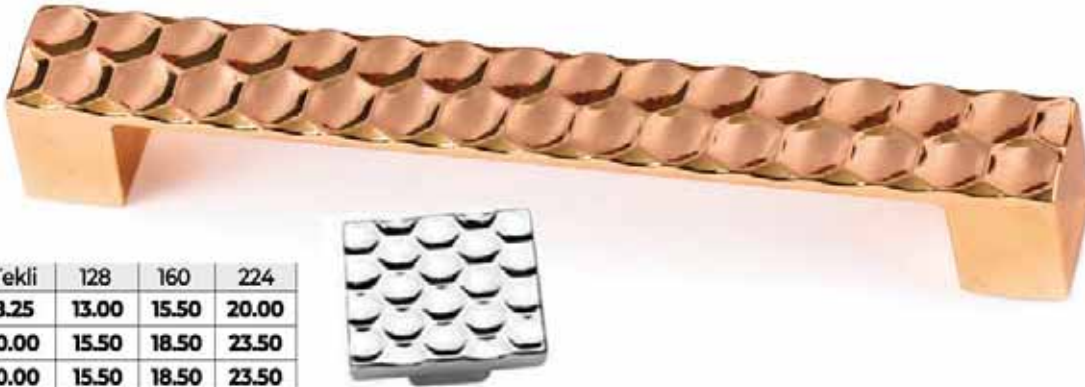

Renk/Boy	Tekli	128	160	224
Krom/Siyah	8.25	13.00	15.50	20.00
Altın	10.00	15.50	18.50	23.50
A.Sarı/A.Bakır	10.00	15.50	18.50	23.50

50 400

**371 Dilara**



Renk/Boy	96	128	192
Krom/Mkr/St	4.60	6.75	14.25

100 800  
100 800  
50 400

### 372 Dilara



Renk/Boy	96	128
Krom/Siyah	11.45	12.90
Inox/Antik	12.45	14.05
Altın/Rose	14.30	16.20

50  400

### 373 Ezgi



Renk/Boy	128	160	192	224
Krom/Siyah	16.05	18.05	20.90	23.75
Inox	16.75	18.90	21.75	24.75
Antik	17.75	20.60	22.90	25.75

50  400

### 374 Merve



Renk/Boy	96	160	224
Krom/Siyah	9.60	15.45	18.20
Inox/Antik	10.30	16.75	20.05
Altın/Rose	12.45	18.60	23.20

75  600  
50  400

### 375 Sarmaşık Motif



Renk/Boy	96	128
Krom/Siyah	10.35	14.15
Altın	14.30	20.25

30  240

### 376 Zamak Eko Şahin



Renk/Boy	160	192	224
Krom/Siyah	7.75	8.50	9.30
Inox	9.30	10.10	10.85

50 400

### 377 Zamak Şahin



Renk/Boy	160	192	224
Krom/Siyah	7.35	8.75	10.00
Inox	8.90	10.30	11.55

50 400

### 378 Eko Yalı



Renk/Boy	128	160
Krom	3.65	4.50

50 400

### 379 Nil



Renk/Boy	96	128
St/M.Krom	4.35	6.45
Krom	4.35	6.45
Kr/Inox	5.90	8.20

100 400  
50 400

### 380 Kılıç



Renk/Boy	128-160	192-224	160
Krom/Siyah	9.30	10.40	6.60
Krom/Inox	10.70	11.25	7.25

50 400



### 381 Zamak Boy



Renk/Boy	96	128	160	224
Krom/Mkr/St	10.20	12.00	14.00	20.00

50  400

### 382 Kartaca



Renk/Boy	160-192
Krom/Siyah	7.65
Krom/İnox	8.75

50  400

### 383 Selvi



Renk/Boy	128	160
Krom/Siyah	5.35	5.70
Kr/İnox	7.10	6.80

50  400

### 384 Yeni Köprü



Renk/Boy	128	192	224
Krom/Siyah	12.00	13.00	16.15
İnox	13.55	15.00	17.70

50  400

### 385 Berilay



Renk/Boy	96	128	160
Krom/Siyah	5.40	6.65	7.25
Krom/İnox	6.20	7.60	8.35

50  400

**386 Elit**



Renk/Boy	96	128	160
Krom	5.75	7.70	9.20
Altın	9.30	12.40	15.05

100  
100  
50 800  
400

**387 Armada**



Renk/Boy	128	160	192	224
Krom	6.35	7.10	8.15	9.15
Altın	8.45	9.30	11.00	12.55

50 400

**388 Klasik**



Renk/Boy	128	160	192	224
Krom/Siyah	6.60	7.45	9.30	10.40
Inox	7.65	8.45	10.15	11.85

50 400

**389 Zamak Çizgili**



Renk/Boy	128	160	192	224
Kr/M.Krom	6.60	7.45	9.30	10.40

50 400

**390 Petek**



Renk/Boy	Tekli	128	160	224
Krom	5.15	5.95	6.90	10.45

100  
50 400  
400

### 391 Lama



Renk/Boy	128	160	192
Krom/Mkr/St.	9.85	10.40	17.25
Kr/Inox	11.35	11.95	18.75

50  400

### 392 Hisar



Renk/Boy	96	128	160	224
Krom/Mkr/St.	5.80	9.50	12.50	18.00
Kr/Inox	7.20	10.90	14.00	19.50

100  400  
50  400

### 393 Eğik



Renk/Boy	128	160
Krom	9.05	9.70
Kr/Inox	10.40	11.15

50  400

### 394 Kemer



Renk/Boy	128	160	192
Krom/M.Kr	5.80	6.65	7.90
Kr/Inox	6.60	7.60	9.00

50  400



**395 Yeni Oval Düz**



50 400

Renk/Boy	32
Krom/Siyah	8.65
Altın	11.00

**396 Halka Düz**



50 400

Renk/Boy	64
Krom/Siyah	8.65
Altın	11.00

**397 Yeni Oval Kumlu**



50 400

Renk/Boy	32
Krom/Siyah	8.65
Altın	11.00

**398 Halka Kumlu**



50 400

Renk/Boy	64
Krom/Siyah	8.65
Altın	11.00

**399 Yeni Oval Çizgili**



50 400

Renk/Boy	320
Krom/Siyah	10.30
Inox/Antik	11.15
Altın/Rose	12.20

**400 Halka Çizgili**



50 400

Renk/Boy	288
Krom/Siyah	11.15
Inox/Antik	12.20
Altın/Rose	12.90

**401 Tekli Halka**



100 800

Renk/Boy	64
Krom/Siyah	8.00
Altın/Antik	10.00

**402 Kare**



50 400

Renk/Boy	64
Krom/Siyah	11.90
Altın/Antik	13.75

**403 V Kulp**



50 400

Renk/Boy	96
Krom	14.00
Krom/Inox	15.75

**404 Yaprak**



100 800  
50 400

Renk/Boy	32	96
Krom/Mkr/St	5.30	8.50

### 405 Plastik Gömme Krom



Renk/Boy	Oval	Yuvarlak
Krom	5.40	2.25

25 200  
100 800

### 406 Plastik Gömme



Renk/Boy	Oval	Yuvarlak
Renkli	3.05	1.35

25 200  
100 800

### 407 Yeni Tabaka



Renk/Boy	Tekli	32	64	96
Krom/MKr	4.70	5.80	7.95	10.80

100 800  
75 600  
50 400  
25 200

### 408 Yeni Tabaka

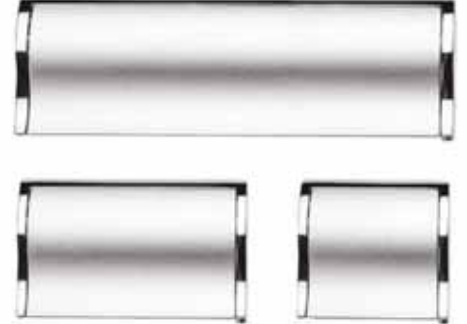

Renk/Boy	Tekli	32	64	96
Krom/MKr	4.70	5.80	7.95	10.80

100 800  
75 600  
50 400  
25 200

### 409 Kenar Gömme



Renk/Boy	128
M.Krom/Siyah	13.20

50 400

### 410 Gömme



Renk/Boy	32	96
Krom/MKr/St	5.25	7.20

100 800  
50 400

deri  
leather



### 411 Deri Kare Kol



Renk/Boy	Düğme	128
Krom	15.60	16.25
Altın	16.25	16.90
Inox	16.90	17.55

100  800  
150  1200

### 412 Deri Orinkli



Renk/Boy	Düğme	Sarkaç	128
Krom/Taba	8.10	12.00	19.50
Altın	8.45	14.00	20.80
Inox	8.85	15.00	22.10

150  1200  
150  1200  
100  800

### 413 Deri İpli



Renk/Boy	Düğme	96	128
Krom/Taba	8.75	15.60	17.70
Altın	9.40	16.40	16.90
Inox	9.75	18.20	19.00

200  1600  
100  800  
100  800

### 414 Deri Burma



Renk/Boy	Düğme	128
Krom/Taba	15.60	16.25
Altın	16.25	16.90
Inox	16.90	17.55

100  800

### 415 Deri



Renk/Boy	32	64
Krom/Taba	13.50	17.50
Altın	14.95	19.50
Inox	15.50	20.50

100  800

### 416 Enes Sarkaç



Renk/Boy	Sarkaç
Krom/Taba	22.00
Altın	23.00
Inox	24.00

100  800

**411** Derili Elips



Renk/Boy	32	128
Krom	18.50	31.90
Altın	20.50	36.00
Roz/Bronz	22.00	37.50

100 800  
100 800

**412** Akasya Deri



Renk/Boy	Düğme	96	128
Krom	16.00	23.00	25.00
Altın	16.90	25.00	26.00
İnox	17.50	26.00	27.50

100 800  
50 400

**413** Simit



Renk/Boy	Düğme	-	-
Krom	21.30	-	-
Altın	22.40	-	-
İnox	22.00	-	-

50 400

**414** Deri Yuvarlak Kol



Renk/Boy	Düğme	128
Krom	15.00	15.60
Altın	15.60	16.30
İnox	16.30	16.90

100 800

**415** Fulya



Renk/Boy	32	-
Krom/Taba	16.30	-
Altın	16.90	-
İnox	17.50	-

100 800

**415** Kamelya



Renk/Boy	Sarkaç
Krom	29.30
Altın	31.30
İnox	32.50

100 800

ekonomik  
economic



**417 Düz**

Boy/Renk	Saten	M.Krom	Krom
96	3.60	3.60	3.60

100  800**418 Noktalı**

Boy/Renk	Saten	M.Krom	Krom
64	2.70	2.70	2.70
96	3.60	3.60	3.60

100  800**419 Baklavalı**

Boy/Renk	Saten	M.Krom	Krom
96	3.60	3.60	3.60

100  800**420 Çift Baklavalı**

Boy/Renk	Saten	M.Krom	Krom
96	3.60	3.60	3.60

100  800**421 Yeni Düz**

Boy/Renk	Saten	Krom	M.Krom	Kr/Inox
96	5.60	5.60	5.60	6.60
128	7.50	7.50	7.50	8.95

100  800  
50  400**422 Yeni Noktalı**

Boy/Renk	Saten	M.Krom	Krom
96	5.60	5.60	5.60

100  800**423 Kareli**

Boy/Renk	Saten	Krom	M.Krom
96	5.60	5.60	5.60
128	7.50	7.50	7.50

100  800  
50  400**424 Stil**

Boy/Renk	Saten/M.Kr	Krom	Kr/Inox
96	4.35	4.35	4.95
128	5.95	5.95	6.60

100  800  
50  400**425 Eko Papyon**

Boy/Renk	Saten/M.Kr	Krom	Kr/Inox
96	4.90	4.90	5.80
128	6.70	6.70	7.60

100  800  
50  400**426 Deve Tabanı**

Boy/Renk	Saten/M.Kr	Krom	Kr/Inox
64	3.40	3.40	3.95
96	3.95	3.95	3.95

200  1600  
100  800

**427 Kalın Yay**



Boy/Renk	Saten	M.Krom	Krom
96	3.8vt0	3.80	3.80

100 800

**428 Sülün**



Boy/Renk	Krom	St/M.Krom	Inox
96	2.70	2.70	2.70

150 1200

**429 Eko Ayaklı Noktalı**



Boy/Renk	Saten/M.Kr	Krom
96	3.00	3.00

100 800

**430 Eko Nil**



Boy/Renk	Saten/M.Kr	Krom	Kr/Inox
96	4.35	4.35	5.80
128	6.35	6.35	7.55

100 800  
50 400

**431 Ördek**



Boy/Renk	Saten/M.Kr	Krom	Kr/Inox
96	3.95	3.95	5.20

100 800

**432 Ayaklı Ördek**



Boy/Renk	Nikel/Inox	Krom	Nikel/Inox
96	3.00	3.00	4.00
128	4.50	4.50	4.90

150 1200  
75 600

**433 Dokuz Baklavalı**



Boy/Renk	Saten	M.Krom	Krom
96	5.15	5.15	5.15

100 800

**434 Badem**



Boy/Renk	Saten/M.Kr	Krom
96	5.90	5.90

100 800

**435 Avci**



Boy/Renk	Saten/M.Kr	Krom
96	4.90	4.90

100 800

**436 Kare**



Boy/Renk	Saten/M.Kr	Krom
96	6.95	6.95

100 800



## 437 Venüs



Boy/Renk	Krom	Kr/Inox
96	4.50	5.25
128	6.25	7.00

100 50 800 400

## 438 Hasır



Boy/Renk	Krom	Saten	M.Krom
64	4.00	4.00	4.00
96	6.40	6.40	6.40
128	8.30	8.30	8.30

150 100 50 1200 800 400

## 439 Şebboy



Boy/Renk	Krom	Saten	Kr/Inox
96	9.90	9.90	11.15

100 50 800

## 440 Eko Yonca



Boy/Renk	Kr/M.Kr	Inox	Kr/Inox
96	5.20	5.70	5.70
128	6.40	7.00	7.00
160	7.50	8.20	8.20

100 50 800 400

## 441 Torino



Boy/Renk	Krom
160-192	6.70

50 50 400

## 442 Sultan



Boy/Renk	Krom	Altın	Rose
96	10.30	12.50	13.65
128	16.40	18.70	19.50

100 50 800

## 443 Vizyon



Boy/Renk	Krom	Altın	Siyah
128	9.20	10.90	9.20
160	10.90	13.90	10.90
192	15.40	21.35	15.40

50 50 400

## 444 Beyit



Boy/Renk	Krom	Kr/Inox
96	9.75	11.25
128	11.50	13.20
160	12.20	13.95
192	14.30	16.40

100 50 800 400

## 445 Sıla



Boy/Renk	Krom	Altın	Antik
128	10.65	12.00	12.70

50 50 400

## 446 Zümrüt



Boy/Renk	Krom	Saten	M.Krom
96	10.10	10.10	10.10
128	11.60	11.60	11.60
160	13.10	13.10	13.10

50 50 400



pendulum  
sarkaçlar

## 447 Orient Halka



Boy/Renk	Krom	Füme/Rose	Altın/Siyah	Ahşap
Sarkaç	11.00	11.50	11.50	12.35

35  280

## 448 Belo Sarkaç



Boy/Renk	Krom/Siyah	Inox	Antik	Altın/Rose
Sarkaç	18.60	21.45	21.45	23.60

30  240

## 449 Natal Sarkaç



Boy/Renk	Krom/Siyah	Inox	Antik	Altın/Rose
Sarkaç	15.75	17.20	17.20	19.35

50  400

## 450 Alegre Sarkaç

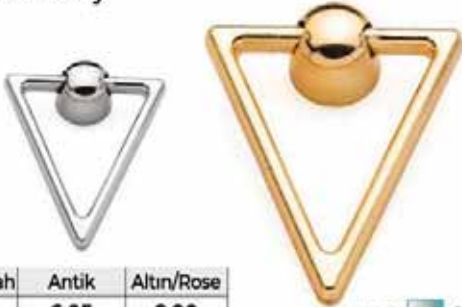

Boy/Renk	Krom/Siyah	Antik	Altın/Rose
Sarkaç	5.75	6.05	8.90

100  800

## 451 Teresa Sarkaç



Boy/Renk	Krom/Siyah	Antik	Altın/Rose
Sarkaç	4.20	4.20	5.20

100  800

## 452 Agrelo Sarkaç



Boy/Renk	Krom/Siyah	Antik	Altın/Rose
Sarkaç	6.60	6.05	8.90

100  800

## 453 Junin Sarkaç



Boy/Renk	Krom/Siyah	Antik	Altın/Rose
Sarkaç	5.45	5.75	7.60

100  800

**454** Yüzüklü Halka Sarkaç



50 400

Boy/Renk	Krom	Antik/Siyah	Altın/Rose
Sarkaç	8.20	8.20	9.30

**455** Üçgen



50 400

Boy/Renk	Krom	Antik/Siyah	Altın/Rose
Sarkaç	8.50	8.50	9.00

**456** Halka Sarkaç



50 400

Boy/Renk	Krom/Siyah	Antik	Altın/Rose
Sarkaç	7.50	7.50	8.50

**457** Kare Sarkaç

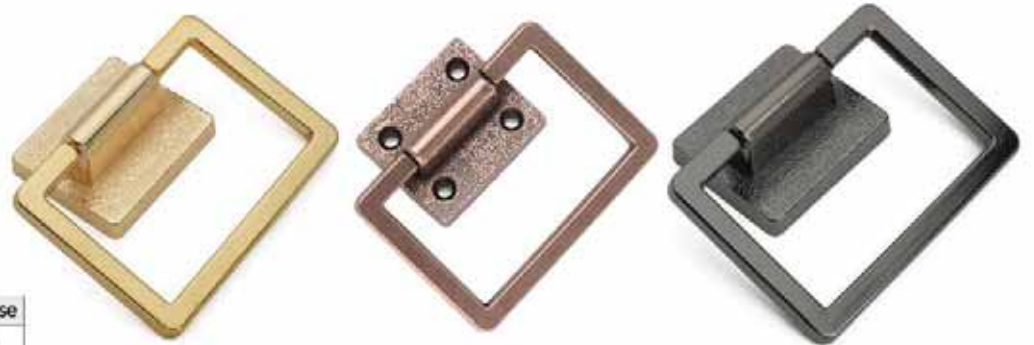

50 400

Boy/Renk	Krom/Siyah	Antik	Altın/Rose
Sarkaç	14.75	16.00	16.00

**458** Çiftli Sarkaç



50 400

Boy/Renk	Krom/Siyah	Antik	Altın/Rose
Sarkaç	14.95	17.55	16.25

**459** Yuvarlak Taban Halka Sarkaç



75 600

Boy/Renk	Krom/Siyah	Antik	Altın/Rose
Sarkaç	8.25	8.25	9.60



**460** Oval Taban  
Porselen Sarkaç
50  400

Boy/Renk	Krom	Altın	Rose/Bronz
Sarkaç	31.20	27.30	29.90

**461** Çiçek Taban  
Porselen Sarkaç
50  400

Boy/Renk	Krom	Altın	Rose/Bronz
Sarkaç	28.60	31.20	32.50

**462** Oval Taban  
Gözde Sarkaç
50  400

Boy/Renk	Krom	Altın	Rose/Bronz
Sarkaç	11.70	13.00	14.30

**463** Çiçek Taban  
Gözde Sarkaç
50  400

Boy/Renk	Krom	Altın	Rose/Bronz
Sarkaç	16.25	17.55	18.20

**464** Oval Taban  
Mekik Sarkaç
50  400

Boy/Renk	Krom	Altın	Rose/Bronz
Sarkaç	13.00	14.30	15.60

**465** Çiçek Taban  
Mekik Sarkaç
50  400

Boy/Renk	Krom	Altın	Rose/Bronz
Sarkaç	16.90	18.20	19.50

**466** Oval Taban  
Kristal Sarkaç
50  400

Boy/Renk	Krom	Altın	Rose/Bronz
Sarkaç	16.90	18.20	19.50

**467** Çiçek Taban  
Kristal Sarkaç
50  400

Boy/Renk	Krom	Altın	Rose/Bronz
Sarkaç	21.45	24.05	25.35

**468** Oval Taban  
Damla Sarkaç
50  400

Boy/Renk	Krom	Altın	Rose/Bronz
Sarkaç	14.85	16.15	16.90

**469** Çiçek Taban  
Damla Sarkaç
50  400

Boy/Renk	Krom	Altın	Rose/Bronz
Sarkaç	19.50	20.80	22.10

**470 Yuvarlak Taban Porselen Sarkaç**



100 800

Boy/Renk	Krom	Altın	Rose/Bronz
Sarkaç	26.00	28.60	29.90

**471 Almati**



50 400

Boy/Renk	Krom/Antik	Altın	Siyah/Beyaz
Sarkaç	11.00	11.75	11.00

**472 Yuvarlak Taban Gözde Sarkaç**



100 800

Boy/Renk	Krom	Altın	Rose/Bronz
Sarkaç	9.75	11.70	13.00

**473 Yasemin Sarkaç**



100 800

Boy/Renk	Krom	Altın	Rose/Bronz
Sarkaç	9.75	10.95	11.45

**474 Yuvarlak Taban Mekik Sarkaç**



100 800

Boy/Renk	Krom	Altın	Rose/Bronz
Sarkaç	11.70	13.00	14.30

**475 Sole Sarkaç**



100 800

Boy/Renk	Krom	Altın	Rose/Bronz
Sarkaç	11.50	12.00	13.00

**476 Yuvarlak Taban Kristal Sarkaç**



100 800

Boy/Renk	Krom	Altın	Rose/Bronz
Sarkaç	16.15	16.90	17.55

**477 Rio Sarkaç**



100 800

Boy/Renk	Krom	Altın	Rose/Bronz
Sarkaç	10.80	11.70	12.35

**478 Yuvarlak Taban Damla Sarkaç**



100 800

Boy/Renk	Krom	Altın	Rose/Bronz
Sarkaç	12.35	13.65	14.30

**479 Favela Sarkaç**



50 400

Boy/Renk	Krom	Altın	Rose/Bronz
Sarkaç	10.80	11.70	12.35

düğmeler  
buttons



**490 Misket Düğme 19mm**

Boy/Renk	Krom	Siyah	Saten/M.Kr
Düğme	3.35	3.35	3.35

200  1600
**491 Misket Düğme 25mm**

Boy/Renk	Krom	Siyah	Saten/M.Kr
Düğme	5.35	5.35	5.35

100  800
**492 Düz Düğme**

Boy/Renk	Krom	Siyah	Saten/M.Kr
Düğme	3.50	3.50	3.50

200  1600
**493 Noktalı Düğme**

Boy/Renk	Krom	Siyah	Saten/M.Kr
Düğme	3.50	3.50	3.50

200  1600
**494 Baklavalı Düğme**

Boy/Renk	Krom	M.Krom	Saten
Düğme	3.50	3.50	3.50

200  1600
**495 Çift Baklavalı Düğme**

Boy/Renk	Krom	M.Krom	Saten
Düğme	3.50	3.50	3.20

200  1600
**496 Ay Düğme**

Boy/Renk	Krom	M.Krom	Saten
Düğme	2.80	2.80	2.80

200  1600
**497 Boğaziçi Düğme**

Boy/Renk	Krom	M.Krom	Saten
Düğme	2.80	2.80	2.80

200  1600
**498 Nergis Düğme**

Boy/Renk	Krom	Siyah	Saten/M.Kr
Düğme	3.45	3.45	3.45

200  1600
**499 Bahar Düğme**

Boy/Renk	Krom	Siyah	Saten/M.Kr
Düğme	3.45	3.45	3.45

200  1600

**500** Tırnak Düğme



Boy/Renk	Krom	Siyah	Saten/M.Kr
Düğme	2.85	2.85	2.85

200 1600

**501** Parmak Düğme



Boy/Renk	Krom	Siyah	Saten/M.Kr
Düğme	3.20	3.20	3.20

200 1600

**502** Kare Düğme



Boy/Renk	Krom	M.Krom	Saten
Düğme	4.00	4.00	4.00

200 1600

**503** Kare Düz Düğme



Boy/Renk	Krom	M.Krom	Saten
Düğme	4.00	4.00	4.00

200 1600

**504** Mermi Düğme



Boy/Renk	Krom	M.Krom	Saten
Düğme	2.85	2.85	2.85

200 1600

**505** Gelincik Kristal Düğme



Boy/Renk	Krom	M.Krom	Saten
Düğme	5.45	5.45	5.45

100 800

**506** Yarım Ay Düğme 32mm



Boy/Renk	Krom	M.Krom	Saten
Düğme	3.40	3.40	3.40

200 1600

**507** Açelya Düğme



Boy/Renk	Krom	M.Krom	Saten
Düğme	3.40	3.40	3.40

200 1600

**508** Petekli Düğme 40x40



Boy/Renk	Krom
Düğme	5.80

50 400

**509** İnci Düğme 40x40



Boy/Renk	Krom
Düğme	8.50

50 400



## 510 Mine Düğme



Boy/Renk	Krom	Altın
Düğme	16.90	18.60

100  800

## 511 Yeni Kare Düğme



Boy/Renk	Krom/Siyah	Altın
Düğme	6.15	7.35

50  400

## 512 Sedef Düğme



Boy/Renk	Krom	M.Krom	Saten
Düğme	3.40	3.40	3.40

200  1600

## 513 Mantar Düğme



Boy/Renk	Renkli
Düğme	1.90

200  1600

## 514 İrem Düğme



Boy/Renk	Krom/Siyah	Inox/Antik	Altın
Düğme	6.05	6.30	7.30

200  1600

## 515 Venüs Düğme



Boy/Renk	Krom/Siyah	Antik	Altın
Düğme	4.60	4.75	5.75

200  1600

## 516 Villa Düğme



Boy/Renk	Krom/Siyah	Inox/Rose	Altın
Düğme	7.90	8.15	9.05

150  1200

## 517 Safir Düğme Mineli



Boy/Renk	Krom	Altın/Rose
Düğme	8.45	9.60

100  800

## 518 Elmas Düğme Mineli



Boy/Renk	Krom	Altın/Rose
Düğme	12.00	12.90

100  800

## 519 Sardunya Düğme Mineli



Boy/Renk	Krom	Altın/Rose
Düğme	12.00	12.90

100  800



**520 Oval Tırtıklı**



Boy/Renk	Krom/Siyah	Altın	Rose/Bronz
Düğme	12.50	13.65	14.30

100 800

**521 Lama**



Boy/Renk	Krom/Siyah	Altın	Rose/Bronz
Düğme	10.70	12.25	13.00

100 800

**522 Konik**



Boy/Renk	Krom/Siyah	Altın	Rose/Bronz
Düğme	15.35	15.35	15.35

100 800

**523 Kare Piramit**



Boy/Renk	Krom/Siyah	Altın	Rose/Bronz
Düğme	16.15	16.15	16.15

100 800

**524 Kupa Düğme Taşlı**



Boy/Renk	Krom/Siyah	Altın	Rose/Bronz
Düğme	13.30	13.65	14.85

100 800

**525 Kupa Düğme**



Boy/Renk	Krom/Siyah	Altın	Rose/Bronz
Düğme	11.35	11.70	12.90

100 800

**526 L Süs**



Boy/Renk	Krom/Siyah	Altın	Rose/Bronz
Düğme	9.65	11.35	11.90

200 1600

**527 Barca**



Boy/Renk	Krom/Siyah	Altın	Rose/Bronz
Düğme	14.95	16.90	18.20

100 800

**528 Mercan Düğme**



Boy/Renk	Krom/Siyah	Altın	Rose/Bronz
Düğme	6.80	7.30	7.80

200 1600

**529 Angolo**



Boy/Renk	Krom/Siyah	Altın	Rose/Bronz
Düğme	21.45	22.10	23.40

50 400

**480** Ø 40 Ahu Düğme



Boy/Renk	Krom/Siyah	Inox/Antik	Altın
Düğme	8.30	9.30	9.75

75 600

**481** Ø 35 Ahu Düğme



Boy/Renk	Krom/Siyah	Inox/Antik	Altın
Düğme	7.45	8.15	8.60

75 600

**482** Zamak Mantar Düğme



Boy/Renk	Krom/Siyah	Inox/Antik	Altın
Düğme	4.75	5.05	5.75

150 1200

**483** Dolunay Düğme



Boy/Renk	Krom/Siyah	Inox/Antik	Altın
Düğme	5.15	5.45	6.30

150 1200

**484** Model-1



Boy/Renk	Siyah	Antik
Düğme	3.15	3.00

200 1600

**485** Model-2



Boy/Renk	Siyah	Antik
Düğme	3.15	3.00

200 1600

**486** Model-3



Boy/Renk	Siyah	Antik
Düğme	3.15	3.00

200 1600

**487** Model-4



Boy/Renk	Siyah	Antik
Düğme	3.15	3.00

200 1600

**488** Model-5



Boy/Renk	Siyah	Antik
Düğme	3.15	3.00

200 1600

**489** Çizgili Düğme



Boy/Renk	Krom/Siyah	Saten/M.Kr
Düğme	3.80	3.80

150 1200

askılar ve portmantolar  
hangers



**530** Selen Askı Portmanto



Boy/Renk	Krom	Altın	Antik
Askı	7.15	8.25	7.15
Port.	9.35	11.90	9.35

100 800  
50 400

**531** Lale Askı Portmanto



Boy/Renk	Krom	Altın	Antik
Askı	7.00	9.85	9.85
Port.	10.65	14.30	14.30

75 600  
50 400

### 532 Alev Portmanto



Boy/Renk	Krom/Siyah	Antik	Altın
Port.	15.15	17.85	17.85

50  400

### 533 Damla Portmanto



Boy/Renk	Krom/Beyaz	Antik	Altın
Port.	12.70	15.80	15.80

50  400

### 534 Sümbül Askı Portmanto



Boy/Renk	Krom/Krom	Krom/Inox	Altın/Altın
Askı	20.90	20.90	24.30
Port.	29.15	29.15	33.85

40  320  
25  200

### 535 Nurşah Askı Portmanto



Boy/Renk	Krom/Krom	Krom/Inox	Altın/Altın
Askı	22.80	22.80	26.00
Port.	26.30	26.30	29.80

40  320  
25  200

### 536 Efsane Portmanto



Boy/Renk	Krom	Antik	Altın/Füme
Port.	14.50	15.00	17.20

40  320

### 537 Lilyum Askı Portmanto



Boy/Renk	Krom	Antik	Altın/Füme
Askı	8.75	9.00	11.00
Port.	12.00	12.00	15.20

40  320  
50  400

**538** Gala Portmanto



Boy/Renk	Krom/Siyah	Altın/Antik
Port.	10.25	12.50

50 400

**539** Deniz Yıldızı Portmanto



Boy/Renk	Krom/Siyah	Altın/Antik
Port.	8.00	10.50

50 400

**540** Buse Askı Portmanto



Boy/Renk	Krom	Altın
Port.	25.40	31.75

40 320

**541** Çapa Askı



Boy/Renk	Krom/Siyah	Altın/Füme
Askı	13.00	16.00

50 400

**542** Klas Noktalı Askı Portmanto



Boy/Renk	Krom/Boyalı
Askı	4.05
Port.	5.90

100 800  
50 400

**543** Kesit Portmanto



Boy/Renk	Krom/Antik	Altın/Füme
Port.	12.90	16.90

40 320



### 544 Fiko Askı Portmanto



Boy/Renk	Krom/Sarı	Siyah/M.kr
Askı	6.15	6.15
Port.	9.00	9.00

100 800  
50 400

### 545 Boncuk Askı Portmanto



Boy/Renk	Kr/Siyah-Beyaz-Mkr	Krom/Krom
Askı	8.15	8.15
Port.	11.50	11.50

75 600  
50 400

### 546 Noktalı Askı Portmanto



Boy/Renk	Krom/Sarı	Saten/M.Kr
Askı	4.80	4.80
Port.	6.75	6.75

100 800  
100 800

### 547 Motif Askı Portmanto



Boy/Renk	Krom/Sarı	Siyah/M.Kr
Askı	4.80	4.80
Port.	6.75	6.75

100 800  
100 800

### 548 Rubi Askı Portmanto

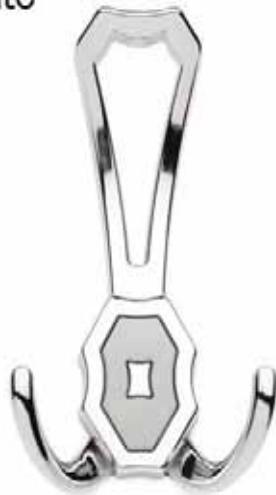

Boy/Renk	Krom
Askı	7.00
Port.	10.25

100 800  
50 400

### 549 Seylan Askı Portmanto



Boy/Renk	Krom	Saten/M.Kr
Askı	15.05	15.05
Port.	17.95	17.95

50 400  
50 400

**550 Stella Askı Portmanto**



Boy/Renk	Krom/Siyah	Altın/Rose
Askı	15.20	19.80
Port.	18.30	24.00

50 400  
30 240

**551 Aris Askı Portmanto**



Boy/Renk	Krom/Siyah	Altın/Rose
Askı	10.70	16.00
Port.	15.50	23.30

50 400  
40 320

**552 Aynalı Askı Portmanto**



Boy/Renk	Krom/Siyah
Askı	14.00
Port.	17.70

50 400  
30 240

**553 Berfin Askı Portmanto**



Boy/Renk	Krom	Siyah/M.kr
Askı	5.70	5.70
Port.	8.45	8.45

100 800  
50 400

**554 Açık Askı Portmanto**



Boy/Renk	Krom/Siyah	Altın/Rose
Askı	14.50	19.00
Port.	21.50	29.30

50 400  
30 240

**555 Yelpeze - Yaprak Askı**

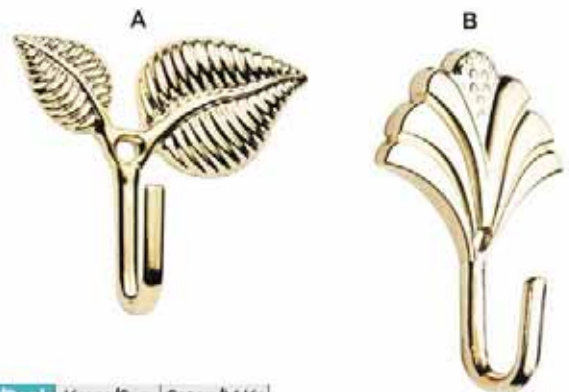

Boy/Renk	Krom/Sarı	Saten/M.kr
A	4.50	4.50
B	4.50	4.50

100 800

**556 Armada Askı Portmanto**

Boy/Renk	Krom	Saten/M.Kr
Askı	7.10	7.10
Port.	10.50	10.50

100 800  
50 400

**557 Sırma Askı Portmanto**

Boy/Renk	Krom/Antik	Altın
Askı	7.90	9.80
Port.	11.00	15.20

50 400  
50 400

**558 Damla Askı Portmanto**

Boy/Renk	Krom	Saten/M.Kr
Askı	8.10	8.10
Port.	11.30	11.30

100 800  
50 400

**559 Star Askı Portmanto**

Boy/Renk	Krom	Saten/M.Kr
Askı	8.10	8.10
Port.	11.30	11.30

100 800  
50 400

**560 Nergis Askı Portmanto**

Boy/Renk	Krom	Saten/M.Kr
Askı	7.65	7.65
Port.	10.40	10.40

100 800  
50 400

**561 Burç Askı Portmanto**

Boy/Renk	Krom/Siyah	Sı/M.Krom
Askı	6.15	6.15
Port.	9.00	9.00

100 800  
50 400



**562** Eta Portmanto



Boy/Renk	Krom/Sarı	Siyah/M.Kr
Port.	9.00	9.00

50 400

**563** Pelikan Portmanto



Boy/Renk	Krom/Sarı	Siyah/M.Kr
Port.	7.00	7.00

50 400

**564** Sarıklı Askı



Boy/Renk	Krom/Sarı	Siyah/M.Kr
Askı	5.50	5.50

100 800

**565** Kobra Askı



Boy/Renk	Krom/Boyalı Saten/M.Kr	Siyah/M.Kr
Askı	4.60	4.60

100 800

**566** Kemerli Askı



Boy/Renk	Krom/Sarı	Siyah/M.Kr
Askı	5.50	5.50

100 800

**567** Çizgili Askı



Boy/Renk	Krom/Sarı	Siyah/M.Kr
Askı	5.50	5.50

100 800

**568** Lale Askı



Boy/Renk	Krom/Sarı	Siyah/M.Kr
Askı	4.85	4.85

100 800

**569** Roket Askı



Boy/Renk	Krom/Boyalı Saten/M.Kr	Siyah/M.Kr
Askı	3.00	3.00

100 800

**antik serisi**  
antique series

**570** Elit Antik



Boy/Renk	Antik Sarı	Antik Bakır
96	6.00	6.00
128	7.90	7.90
160	9.80	9.80

100 800  
100 800  
50 400

**571** Pelit Antik



Boy/Renk	Antik Sarı	Antik Bakır
96	6.00	6.00
128	7.90	7.90

100 800

**572** Narin Antik



Boy/Renk	Antik Sarı	Antik Bakır
96	6.00	6.00
128	7.90	7.90
160	9.80	9.80

50 400

**573** Başak Antik



Boy/Renk	Antik Sarı	Antik Bakır
96	6.00	6.00
128	7.90	7.90
160	9.80	9.80

100 800  
50 400

**574** Çelenk Antik



Boy/Renk	Antik Sarı	Antik Bakır
96	6.00	6.00
128	7.90	7.90

100 800  
50 400

**575** Defne Antik



Boy/Renk	Antik Sarı	Antik Bakır
96	6.00	6.00
128	7.90	7.90

50 400

**576** Hasır Antik



Boy/Renk	Antik Sarı	Antik Bakır
96	6.55	6.55
128	8.35	8.35

100 800  
75 600

**577** Asma Antik



Boy/Renk	Antik Sarı	Antik Bakır
96	7.75	7.75
128	11.70	11.70
160	16.90	16.90

50 400  
50 400  
30 240



## 578 U Papuçlu



Boy/Renk	Antik Sarı	Antik Bakır
64	4.10	4.10
96	4.65	4.65

100 800  
50 400

## 579 Üzümlü



Boy/Renk	Antik Sarı	Antik Bakır
64	3.50	3.50

150 1200

## 580 Çizgili



Boy/Renk	Antik Sarı	Antik Bakır
64	3.65	3.65

150 1200

## 581 Boğaziçi



Boy/Renk	Antik Sarı	Antik Bakır
64	3.10	3.10

150 1200

## 582 Hasır



Boy/Renk	Antik Sarı	Antik Bakır
64	3.95	3.95

150 1200

## 583 64 Meltem



Boy/Renk	Antik Sarı	Antik Bakır
64	3.60	3.60

150 1200

## 584 Selen



Boy/Renk	Antik Sarı	Antik Bakır
Düğme	2.30	2.30
96	3.15	3.15
128	3.35	3.35

100 800  
50 400  
50 400

## 585 Palmiye



Renk/Boy	Sarkaç	64
Antik	6.00	7.90
Antik Gümüş	8.00	10.30
Altın	8.90	10.60

100 800  
50 400

**586** Büyük Boğaziçi Sarkaç



Boy/Renk	Antik Sarı	Antik Bakır
Sarkaç	4.65	4.65

100 800

**587** Küçük Boğaziçi Sarkaç



Boy/Renk	Antik Sarı	Antik Bakır
Sarkaç	2.25	2.25

200 1600

**588** Köşk Sarkaç



Boy/Renk	Antik Sarı	Antik Bakır
Sarkaç	3.95	3.95

100 800

**589** Antik Halka Sarkaç



Boy/Renk	Antik Sarı	Antik Bakır
Sarkaç	2.40	2.40

200 1600

**590** Kalp Sarkaç



Boy/Renk	Antik Sarı	Antik Bakır
Sarkaç	2.25	2.25

200 1600

**591** Ay Sarkaç



Boy/Renk	Antik Sarı	Antik Bakır
Sarkaç	2.25	2.25

200 1600

**592** Gerdan Sarkaç



Boy/Renk	Antik Sarı	Antik Bakır
Sarkaç	2.25	2.25

200 1600

**593** Misket Sarkaç



Boy/Renk	Antik Sarı	Antik Bakır
Sarkaç	2.25	2.25

200 1600



### 594 Büyük Kelebek Mentеше



Boy/Renk	Antik Sarı	Antik Bakır
Menteşe	4.10	4.10

200  1600

### 595 Küçük Kelebek Mentеше



Boy/Renk	Antik Sarı	Antik Bakır
Menteşe	2.70	2.70

400  3200

### 596 Yeni Lale Sarkaç



Boy/Renk	Antik Sarı	Antik Bakır
Sarkaç	2.70	2.70

200  1600

### 597 Yeni Çiçekli Sarkaç



Boy/Renk	Antik Sarı	Antik Bakır
Sarkaç	2.70	2.70

200  1600

### 598 Üzümlü Sarkaç



Boy/Renk	Antik Sarı	Antik Bakır
Sarkaç	2.25	2.25

200  1600

### 599 Damla Sarkaç



Boy/Renk	Antik Sarı	Antik Bakır
Sarkaç	2.25	2.25

200  1600

### 600 Çizgili Sarkaç



Boy/Renk	Antik Sarı	Antik Bakır
Sarkaç	2.25	2.25

200  1600

### 601 Hasır Sarkaç



Boy/Renk	Antik Sarı	Antik Bakır
Sarkaç	2.40	2.40

200  1600



**602** Boğaziçi Düğme



Boy/Renk	Antik Sarı	Antik Bakır
Düğme	2.25	2.25

200 1600

**603** Oval Boğaziçi Düğme



Boy/Renk	Antik Sarı	Antik Bakır
Düğme	2.25	2.25

200 1600

**604** Gerdan Düğme



Boy/Renk	Antik Sarı	Antik Bakır
Düğme	2.25	2.25

200 1600

**605** Misket Düğme



Boy/Renk	Antik Sarı	Antik Bakır
Düğme	2.25	2.25

200 1600

**606** Kalp Düğme



Boy/Renk	Antik Sarı	Antik Bakır
Düğme	2.25	2.25

200 1600

**607** Damla Düğme



Boy/Renk	Antik Sarı	Antik Bakır
Düğme	2.25	2.25

200 1600

**608** Çizgili Düğme



Boy/Renk	Antik Sarı	Antik Bakır
Düğme	2.25	2.25

200 1600

**609** Hasır Düğme



Boy/Renk	Antik Sarı	Antik Bakır
Düğme	2.25	2.25

200 1600

**610** Çelenk Düğme

Boy/Renk	Antik Sarı	Antik Bakır
Düğme	3.40	3.40

200  1600
**611** Narin Düğme

Boy/Renk	Antik Sarı	Antik Bakır
Düğme	3.40	3.40

200  1600
**612** Üzümlü Düğme

Boy/Renk	Antik Sarı	Antik Bakır
Düğme	2.25	2.25

200  1600
**613** Sarıklı Düğme

Boy/Renk	Antik Sarı	Antik Bakır
Düğme	2.25	2.25

200  1600
**614** Milenyum Düğme

Boy/Renk	Antik Sarı	Antik Bakır
Düğme	2.25	2.25

200  1600
**615** Zirve Düğme

Boy/Renk	Antik Sarı	Antik Bakır
Düğme	2.25	2.25

200  1600
**616** Menekşe Düğme

Boy/Renk	Antik Sarı	Antik Bakır
Düğme	3.40	3.40

200  1600
**617** Burç Düğme

Boy/Renk	Antik Sarı	Antik Bakır
Düğme	3.40	3.40

200  1600



**618** Eta Portmanto



Boy/Renk	Antik Sarı	Antik Bakır
Port.	9.50	9.50

50 400

**619** Lale Askı



Boy/Renk	Antik Sarı	Antik Bakır
Askı	5.35	5.35

100 800

**620** Sarıklı Askı



Boy/Renk	Antik Sarı	Antik Bakır
Askı	6.00	6.00

100 800

**621** Kobra Askı



Boy/Renk	Antik Sarı	Antik Bakır
Askı	5.20	5.20

100 800

**622** Selen Askı



Boy/Renk	Antik Sarı	Antik Bakır
Askı	8.25	8.25

100 800

**623** Çizgili Askı



Boy/Renk	Antik Sarı	Antik Bakır
Askı	6.00	6.00

100 800

**624** Tekli Yaprak Askı



Boy/Renk	Antik Sarı	Antik Bakır
Askı	4.70	4.70

100 800

**625** Tekli Yelpaze Askı



Boy/Renk	Antik Sarı	Antik Bakır
Askı	4.70	4.70

100 800



**626** Armada Askı Portmanto Antik

Boy/Renk	Antik Sarı	Antik Bakır
Askı	7.45	7.45
Port.	10.95	10.95

100 800  
50  400

**627** Fiko Askı Portmanto Antik

Boy/Renk	Antik Sarı	Antik Bakır
Askı	6.55	6.55
Port.	9.50	9.50

100 800  
50  400

**628** Noktalı Askı Portmanto Antik

Boy/Renk	Antik Sarı	Antik Bakır
Askı	5.05	5.05
Port.	7.10	7.10

100 800  
100  800

**629** Motif Askı Portmanto Antik

Boy/Renk	Antik Sarı	Antik Bakır
Askı	5.05	5.05
Port.	7.10	7.10

100 800  
50  400

ayaklar  
legs

**630** Ø 42 Alfa Ayak

Boy/Renk	Krom	Statik Boya
6 cm	7.95	7.95
8 cm	8.55	8.55
10 cm	9.55	9.55
12 cm	10.95	10.95
15 cm	12.05	12.05
20 cm	13.95	13.95

**631** Ø 42 Omega Ayak

Boy/Renk	Krom	Statik Boya
6 cm	8.20	8.20
8 cm	8.90	8.90
10 cm	9.50	9.50
12 cm	10.90	10.90
15 cm	12.45	12.45
20 cm	14.65	14.65

**632** Ø 32 Pls. Bingolu Baza Ayağı

Boy/Renk	Krom	Statik Boya
6 cm	7.45	7.45
8 cm	8.00	8.00
10 cm	8.20	8.20
12 cm	9.40	9.40
15 cm	10.50	10.50
20 cm	12.20	12.20

**633** Ø 42 Pls. Bingolu Baza Ayağı

Boy/Renk	Krom	Statik Boya
6 cm	8.00	8.00
8 cm	8.65	8.65
10 cm	9.35	9.35
12 cm	10.80	10.80
15 cm	12.35	12.35
20 cm	14.65	14.65

**634** Ø 51 Pls. Bingolu Baza Ayağı

Boy/Renk	Krom	Statik Boya
6 cm	9.85	9.85
8 cm	10.85	10.85
10 cm	11.75	11.75
12 cm	13.70	13.70
15 cm	15.65	15.65
20 cm	18.70	18.70

**635** Ø 60 Pls. Bingolu Baza Ayağı

Boy/Renk	Krom	Statik Boya
6 cm	11.45	11.45
8 cm	12.65	12.65
10 cm	13.80	13.80
12 cm	15.85	15.85
15 cm	18.20	18.20
20 cm	22.10	22.10



**636** 40x40 Al. Çizgili Kare Ayak



Boy/Renk	Inox	Eloksal
5 cm	9.55	9.20
8 cm	11.25	10.90
10 cm	12.95	12.65
12 cm	14.70	14.30
15 cm	17.50	16.90
20 cm	21.70	21.15
25 cm	26.00	25.20

**637** 40x40 Al. Düz Kare Ayak



Boy/Renk	Inox	Eloksal
5 cm	9.55	9.20
8 cm	11.25	10.90
10 cm	12.95	12.65
12 cm	14.70	14.30
15 cm	17.50	16.90
20 cm	21.70	21.15
25 cm	26.00	25.20

**638** Ø 42 Metal Bingolu Baza Ayağı



Boy/Renk	Krom	Statik Boya
6 cm	14.00	14.00
8 cm	14.70	14.70
10 cm	15.30	15.30
12 cm	17.00	17.00
15 cm	18.60	18.60
20 cm	20.90	20.90

**639** Ø 51 Metal Bingolu Baza Ayağı



Boy/Renk	Krom	Statik Boya
6 cm	16.70	16.70
8 cm	17.70	17.70
10 cm	18.60	18.60
12 cm	20.60	20.60
15 cm	22.70	22.70
20 cm	25.60	25.60

**640** Ø 60 Metal Bingolu Baza Ayağı



Boy/Renk	Krom	Statik Boya
6 cm	18.30	18.30
8 cm	19.50	19.50
10 cm	20.65	20.65
12 cm	22.10	22.10
15 cm	24.00	24.00
20 cm	27.85	27.85

**641** Efe Ayak



Boy/Renk	Beyaz	M.krom/St
6 cm	7.30	6.80
8 cm	7.80	7.30
10 cm	8.30	7.80

**642** Karya Ayak

Renk/Boy	12cm
Kr/Boya	44.00

60  60
**643** Esterya Ayak

Renk/Boy	12cm
Kr/Boya	41.00

60  60
**644** Eğik Ayak

Renk/Boy	10cm
Kr/Boya	36.00
Antik	42.00

80  80
**645** Atlas Ayak

Renk/Boy	10cm
Kr/Boya	19.60
Kr/Boya	21.50

200  200
**646** Kavis Ayak

Renk/Boy	8cm	10cm	12cm
Krom	36.00	39.50	47.00

20  20
**647** Kıvrık Ayak

Boy/Renk	Krom	Boyalı
12cm	20.00	20.00

20  20

**648** Ø60 Masa ve Sehpa Ayağı Tablalı  
(Ahşap İçin)



Boy/Renk	Krom	Statik Boya
41 cm	196.00	196.00
71 cm	219.00	219.00

4 4

**649** Ø76 Masa ve Sehpa Ayağı Tablalı  
(Ahşap İçin)



Boy/Renk	Krom	Statik Boya
41 cm	215.00	215.00
71 cm	250.00	250.00

4 4

**650** Ø60 Masa ve Sehpa Ayağı Tablalı  
(Cam İçin)



Boy/Renk	Krom	Statik Boya
41 cm	195.00	195.00
71 cm	215.00	215.00

4 4

**651** Ø76 Masa ve Sehpa Ayağı Tablalı  
(Cam İçin)



Boy/Renk	Krom	Statik Boya
41 cm	260.00	260.00
71 cm	287.00	287.00

4 4

**652** Ø60 Masa ve Sehpa Ayağı (Ahşap İçin)



Boy/Renk	Krom	Statik Boya
41 cm	42.00	42.00
71 cm	65.00	65.00

4 4

**653** Ø76 Masa ve Sehpa Ayağı (Ahşap İçin)



Boy/Renk	Krom	Statik Boya
41 cm	64.00	64.00
71 cm	90.00	90.00

4 4

**654** Ø60 Masa ve Sehpa Ayağı (Cam İçin)



Boy/Renk	Krom	Statik Boya
41 cm	60.00	60.00
71 cm	77.00	77.00

4 4

**655** Ø76 Masa ve Sehpa Ayağı (Cam İçin)



Boy/Renk	Krom	Statik Boya
41 cm	95.00	95.00
71 cm	125.00	125.00

4 4



**656** Mtl. Bingolu Saplmalı Baza Ayağı  
Ø42 - Ø51 - Ø60

M8			Fiyat Alınız.	
Boy/Renk	Krom	Statik Boya		
5 cm				
8 cm				
10 cm				
12 cm				

M10			Fiyat Alınız.	
Boy/Renk	Krom	Statik Boya		
5 cm				
8 cm				
10 cm				
12 cm				

**657** Pls. Bingolu Saplmalı Baza Ayağı  
Ø42 - Ø51 - Ø60

M8			Fiyat Alınız.	
Boy/Renk	Krom	Statik Boya		
5 cm				
8 cm				
10 cm				
12 cm				

M10			Fiyat Alınız.	
Boy/Renk	Krom	Statik Boya		
5 cm				
8 cm				
10 cm				
12 cm				

**658** Star Ayak

Boy/Renk	Inox	Siyah/Beyaz	Altın
6 cm	8.70	8.40	9.95
8 cm	10.10	9.80	11.95
10 cm	11.45	11.15	13.90

**659** Çizgili Stil Ayak

Boy/Renk	Inox	Siyah/Beyaz	Altın
6 cm	9.60	9.35	10.45
8 cm	11.15	10.80	12.50
10 cm	12.65	12.35	14.50

**660** Metal Raf Ara Bağlantı

Fiyat Alınız.			
Boy/Renk	Ø42	Ø51	Ø60
10 cm			
12 cm			
15 cm			
20 cm			
25 cm			
30 cm			
35 cm			
40 cm			
50 cm			
60 cm			
70 cm			
80 cm			



**661** Merkür Ayak



Boy/Renk	Krom	Antik/Siyah	Altın
16 cm	30.00	27.00	36.50
19 cm	37.00	31.50	43.50

20 16 20 16

**662** Neptün Ayak



Boy/Renk	Krom	Antik/Siyah	Altın
14 cm	29.00	27.50	34.00

20 20

**663** Mercan Ayak



Boy/Renk	Kr/Siyah	Altın/Rose
8cm Düz	100.00	115.00
10cm Düz	105.00	120.00
8cm Desen	110.00	127.00
10cm Desen	115.00	132.00

24 24

**664** Misket Ayak



Boy/Renk	Kr/Siyah	Altın/Rose
17 cm	92.00	106.00
20 cm	98.00	110.00
25 cm	100.00	118.00
30 cm	105.00	120.00

24 24

**665** Vera Ayak



Boy/Renk	Krom	Siyah	Antik	Altın
10 cm	24.00	22.00	21.00	27.50

28 28

**666** Pls. Konik Ayak



Boy/Renk	Beyaz/Ahşap
9 cm	6.30
12 cm	6.90
15 cm	7.30
20 cm	15.40

300 300  
200 200  
150 150  
100 100

**667** Lükens Ayak

Boy/Renk	Renkli	Renkli
8 cm	3.30	3.50
14 cm	5.00	5.50

150  150
**668** Motifli Ayak

Boy/Renk	Renkli	Ceviz	Altın	Metalize
9 cm	3.60	3.60	-	-
12 cm	6.00	6.70	8.00	8.00

120  120  
250  250
**669** Sultan Ayak

Boy/Renk	Renkli	Ceviz	Altın	Metalize
14 cm	8.20	8.90	9.20	9.20

120  120
**670** Pls. Yatay Avak

Boy/Renk	Renkli
12 cm	5.20

250  250
**671** Mina Ayak

Boy/Renk	Beyaz	Ceviz
10 cm	4.20	4.30
12 cm	4.30	4.45
14 cm	4.60	4.75
20 cm	5.10	5.35

250  250
**672** Meriç Ayak

Boy/Renk	Renkli	Varaklı	Ahşap
12 cm	9.60	12.00	14.50

80  80



**673 Nefes Ayak**



Boy/Renk	Kr/Renkli	Altın/Renkli
12 cm	5.80	5.80
15 cm	6.20	6.20
20 cm	7.60	7.60
40 cm	7.60	7.60

200 200  
200 200  
150 150

**674 Akasya Ayak**



Boy/Renk	Beyaz/Siy.	Altın
Düz 15cm	9.00	12.50
Yüzük 15cm	13.80	15.90

200 200

**675 Roza Masa-Sehpa Ayağı**



Boy/Renk	Renkli	Ahşap
43 cm	55.00	60.00
75 cm	110.00	115.00

24 24

**676 Lükens Masa-Sehpa Ayağı**



Boy/Renk	Renkli	Ahşap
Desen 40cm	55.00	60.00
Desen 75cm	110.00	115.00
Düz 40cm	55.00	60.00
Düz 75cm	110.00	115.00

24 24

**677 Lavin Masa-Sehpa Ayağı**



Boy/Renk	Renkli	Ahşap
42 cm	55.00	60.00
75cm	110.00	115.00

250 250  
300 300

**678 Royal Ayak**



Boy/Renk	Renkli	Krom	Ahşap	Mat Krom
12 cm	2.85	6.50	5.65	4.95

200 200

**679 L Ayak**

Boy/Renk	Beyaz	Siyah
10-15 cm	1.70	1.70
Klips	0.50	0.50

 250 250  
300 300

**680 Metal Konik Ayak**

Boy/Renk	Renkli
5 cm	8.20
8 cm	8.50
10 cm	9.40
12 cm	12.30

 250 200  
200 250

**681 Pls. Tombul Ayak**

Boy/Renk	Beyaz	M.Krom	Krom
10 cm	3.40	4.20	4.80

200 200

**682 Pls. Konik Ayak**

Boy/Renk	M.Krom	Krom
5 cm	3.65	5.15
8 cm	3.75	5.35
10 cm	3.85	5.55

 300 300  
250 250  
200 200

**683 Kelebek Ayak**

Boy/Renk	M.Krom
5 cm	3.75
8 cm	3.75
10 cm	4.00

 300 300  
250 250  
200 200

**684 Pls. Köşe Ayak**

Boy/Renk	Boyalı	Boya Taban	Krom Taban
5 cm	3.00	4.30	4.75
8 cm	3.60	4.70	5.20
10 cm	4.30	5.40	5.90

 250 250  
200 200  
150 150

**685** Ø 45 Masa Ayağı 103-B



Fiyat Alınız.

Boy/Renk	Statik Boya
Yuvarlak	

**686** Masa Ayağı 212



Fiyat Alınız.

Boy/Renk	Statik Boya
Kare	

**687** Masa Ayağı 305-1



Fiyat Alınız.

Boy/Renk	Statik Boya
Yuvarlak	
Kare	



**688** Masa Ayağı 508



Fiyat Alınız.

Boy/Renk	Statik Boya
4'lü	

**689** Masa Ayağı 506



Fiyat Alınız.

Boy/Renk	Statik Boya
Kare	

**690** 2'li Masa Ayağı 501



Fiyat Alınız.

Boy/Renk	Statik Boya
2'li	



**aksesuarlar**  
fittings

**691** Metal Dübelli Minifix 16mm



2000

Boy/Renk	Nikel	Çinko
12x15	1.20	1.10

**692** Metal Dübelli Minifix 18mm



2000

Boy/Renk	Nikel	Çinko
13,3x15	1.20	1.10

**693** Plastik Dübelli Minifix 16mm



2000

Boy/Renk	Nikel	Çinko
12x15	0.95	0.85

**694** Plastik Dübelli Minifix 18mm



2000

Boy/Renk	Nikel	Çinko
13,3x15	0.95	0.85

**695** Yatay Fix



2000

Boy/Renk	Çinko
12x15	3.95

**696** Dikey Fix



2000

Boy/Renk	Çinko
12x15	3.60

**697** Kendinden Dübelli Minifix 8'lik



3000

Boy/Renk	Nikel	Çinko
12x15	0.95	0.85

**698** Kendinden Dübelli Minifix 8'lik



3000

Boy/Renk	Nikel	Çinko
13,3x15	0.95	0.85

**699** Kendinden Dübelli Minifix 10'lik



3000

Boy/Renk	Nikel	Çinko
12x15	0.95	0.85

**700** Kendinden Dübelli Minifix 10'lik



3000

Boy/Renk	Nikel	Çinko
13,3x15	0.95	0.85

### 701 Metal Dübel

1000

Boy/Renk		
M 6	8x10	0.37
	8x13	
M 8	10x12	0.54
	10x15	
	10x18	
M 10	13x15	0.75



### 702 Plastik Dübel

5000

Boy/Renk	Renkli
5x9	0.140
5x13	0.140



### 703 Sunta Diş Minifix

1000

Boy/Renk	Nikel	Çinko
12x15	0.82	0.70
13.3x15	0.82	0.70



### 704 Minifix Gövde

1000

Boy/Renk	Nikel	Çinko
12x15	0.57	0.47
13.3x15	0.57	0.47
9.5x15	0.48	0.40



### 705 Minifix Mili Boydan

1000

Boy/Renk	Sekmanlı	Sekmansız
7x68	1.30	1.10
7x86	1.35	1.30



### 706 Hareketli Mil

250

Boy/Renk	Çinko
Hareketli	2.95



### 707 Montebent

1000

Boy/Renk	Çinko
Mini	0.98
32mm	0.77
36mm	0.96
60mm	1.15



### 708 Çakma Somun

1000

Boy/Renk	Çinko
M6	0.48
M8	0.54
M10	1.79



### 709 Tuğla Boşluk Dübeli

500

Boy/Renk	Plastik
Ø 8	0.19
Ø 10	0.23



### 710 Dübel

1000

Boy	Dübel
6'lık	0.062
7'lik	0.065
8'lik	0.069
10'luk	0.13
12'lik	0.325
14'10k	0.775





**711** Pimli Raf Pimi 5mm

1000

Boy/Renk	Nikel
5 mm	0.44



**712** Kare Metal Raf Pimi

1000

Boy/Renk	Nikel
5 mm	0.65



**713** Vantuzlu Cam Pimi

500

Boy/Renk	A	B
5 mm	0.72	0.72



**714** Metal Raf Pimi

1000

Boy/Renk	Çinko
5 mm	0.14



**715** Kristal Raf Pimi

1000

Boy/Renk	Şeffaf
5 mm	0.25



**716** Metal Başlı Raf Pimi

1000

Boy/Renk	Renkli
5 mm	0.125



**717** Contalı Raf Pimi

1000

Boy/Renk	A	B
8mm	0.79	0.79



**718** Çivili Raf Pimi

1000

Renk	Renkli	Şeffaf
	0.052	0.067



**719** Kilitli Gömme Raf Pimi

200

Boy/Renk	Beyaz	Kahve
M6	2.10	2.10
Sunta Diş	2.10	2.10



**720** Gömme Raf Pimi

1000

Boy/Renk	Renkli
M6	0.50



**721** Penguen Ayarlı Raf Tutucu

2

Boy/Renk	Krom	St/M.Krom
	29.60	29.60

**722** Kavis Pelikan Ayarlı Etejer

4

Boy/Renk	Krom	St/M.Krom
	23.00	23.00

**723** Oval Pelikan Ayarlı Etejer

4

Boy/Renk	Krom	St/M.Krom
	23.50	23.50

**724** Pelikan Ayarlı Etejer

100

Boy/Renk	Krom	St/M.Krom
	12.15	12.15

**725** Metal Raf Tutucu Düz

500

Boy/Renk	Krom	Nikel
Pls. Vidalı	1.95	1.69
Mtl. Vidalı	2.35	2.10

**726** Metal Raf Tutucu Pimli

500

Boy/Renk	Krom	Nikel
Pls. Vidalı	1.95	1.69
Mtl. Vidalı	2.35	2.10

**727** Yuvarlak Etejer

100

Boy/Renk	Krom	St/M.Krom
Pls. Vidalı	4.60	4.60
Mtl. Vidalı	4.95	4.95

**728** Yuvarlak Etejer

100

Boy/Renk	Krom	St/M.Krom
Pls. Vidalı	4.60	4.60
Mtl. Vidalı	4.95	4.95

**729** U Cam Etejeri

100

Boy/Renk	Krom	St/M.Krom
Pls. Vidalı	6.40	6.40
Mtl. Vidalı	6.60	6.60

**730** Tırnak Cam Raf Tutucu

500

Boy/Renk	Krom	Nikel
Pls. Vidalı	3.90	3.75
Mtl. Vidalı	4.25	4.05



**731** Oval Cam Etejeri (10 mm)

100

Boy/Renk	Krom	St/M.Krom
Pls. Vidalı	5.95	5.95
Mtl. Vidalı	6.35	6.35



**732** Oval Cam Etejer (Ø32 - Ø42 Boru İçin)

100

Boy/Renk	Krom	St/M.Krom
Pls. Vidalı	5.95	5.95
Mtl. Vidalı	6.35	6.35



**733** Mini Oval Cam Etejeri

200

Boy/Renk	Krom	St/M.Krom
Pls. Vidalı	4.35	4.35
Mtl. Vidalı	4.70	4.70



**734** Ay Cam Etejeri (10mm)

50

Boy/Renk	Krom	St/M.Krom
Pls. Vidalı	9.45	9.45
Mtl. Vidalı	9.95	9.95



**735** Oval Askı Flanşı

250

Boy/Renk	Nikel	Çinko
Pimli	1.60	1.40
Pimsiz	1.40	1.20



**736** Eko Oval Askı Flanşı

250

Renk	Nikel	Çinko
Pimli	1.30	1.15
Pimsiz	1.20	1.00



**737** Oval Uzun Askı Flanşı

200

Boy/Renk	Nikel
M4	2.55
M6	2.55



**738** Flanş

250  
100

Boy/Renk	Çinko
2 Delikli	0.70
4 Delikli	1.45



**739** Sac Flanş

250

Renk	Nikel	Çinko
Sac	-	1.40



**740** Plastik Oval Askı Flanşı

250

Boy/Renk	Renkli	Şeffaf
Pimli	0.25	-
Pimsiz	0.24	0.60





**741 Yuvarlak Ayaklı Lüks Flanş Ø25**

100

Boy/Renk	Krom
Açık	5.30
Kapalı	6.20

**742 Yuvarlak Ayaklı Lüks Flanş Ø16**

200

Boy/Renk	Krom
Açık	3.90
Kapalı	4.30

**743 Yuvarlak Ayaklı Flanş Ø25**

100

Boy/Renk	Krom
Açık	4.60
Kapalı	5.30

**744 Oval Ayaklı Flanş**

150

Boy/Renk	Krom
Açık	3.90
Kapalı	4.30

**745 Yuvarlak Boru Flanşı**

200

Boy/Renk	Krom
Vıdalı	2.85
Vidasız	2.35

**746 Üçgen Boru Flanşı**

250

Boy/Renk	Krom
Vıdalı	3.00
Vidasız	2.75

**747 Uzun Boru Flanşı Ø25**

50

Boy/Renk	Krom
Ø25	5.65

**748 Uzun Boru Flanşı Ø16**

250

Boy/Renk	Krom
Ø16	3.30

**749 Asmalı Flanş**

200

Boy/Renk	Nikel
M4	2.30
M6	2.30

**750 Metal Kapaklı Flanş**

200

Boy/Renk	Krom
Pls. Taban	2.60
Mtl. Taban	3.80



### 751 Yuvarlak Askı Borusu



60mt

1 Baę = 60mt

Boy/Renk	Krom
16mm	21.00
25mm	21.00

### 752 Oval Askı Borusu



60mt

1 Baę = 60mt

Boy/Renk	Krom
15x29	21.00

### 753 Alüminyum Askı Borusu

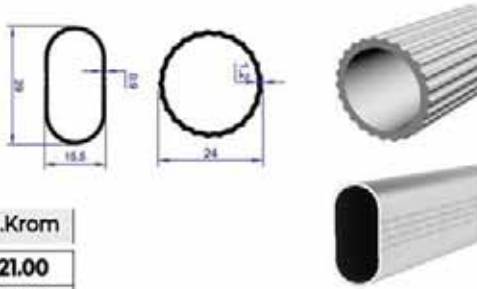

60mt

1 Baę = 60mt

Boy/Renk	M.Krom
Oval	21.00
Yuvarlak	19.50

### 754 Kanca



250

Boy/Renk	Krom
9 Kanca	2.00
5 Kanca	3.90

### 755 T Boru Flanşı



50

Boy/Renk	Krom
ø25	11.20

### 756 L Boru Flanşı



50

Boy/Renk	Krom
ø25	9.90

### 757 Üçlü Boru Flanşı



30

Boy/Renk	Krom
ø25	10.20

### 758 Dörtlü Boru Flanşı



30

Boy/Renk	Krom
ø25	12.50

### 759 Beşik Mekanizması



50

Boy/Renk	Krom
66cm	41.00
80cm	41.00

### 760 Beşik Sallama Aparatı



20

Boy/Renk	Krom
12 cm	13.00
14 cm	13.00
15.5 cm	13.00



**761** Kelebek T Bağlantı

1000

Renk	Nikel	Çinko
	2.45	2.10

**762** Şeffaf T Bağlantı

1500

Renk	Şeffaf
	1.10

**763** Modül Askı Elemanı

100

Renk	Eleman	Kapak	L Vida	Sac
	6.50	2.20	1.30	2.90

**764** Dolap Askı Elemanı

250

Boy/Renk	Renkli
1.2mm	1.15
1.5mm	1.45

**765** Plastik L Köşe

250

Renk	Renkli
	0.165

**766** Plastik Arkalık Bağlantı

1000

Renk	Renkli
	0.047

**767** Tırnaklı Çektirme

100

Renk	Renkli
	1.75

**768** Banyo Dolap Askı Elemanı

100

Renk	Çinko
Vidalı	12.50
Vidasız	11.50

**769** Metal Vida Tapası

250

Boy/Renk	Kı/M.Krom
13	0.75
15	0.90
20	1.25
25	2.75

**770** Tabela Vidası

100

Boy/Renk	Krom
13x20	4.30
17x10	4.30
17x20	5.10
17x30	5.60
17x40	6.50



### 771 Poligrit



1000

Renk	Renkli	Şeffaf
	0.099	0.23

### 772 Vida Tapası



1000

Boy	Minifix	10mm	Allen
	0.036	0.058	0.036

### 773 Kavalye



3000

Boy/Renk	Siyah	Renkli
8x30	0.035	0.068

### 774 Baza Pabucu



500

Boy/Renk	Renkli
Tırnaklı	0.10
Düz	0.10

### 775 Kablo Kanalı



50

Boy/Renk	Renkli
Ø43	1.30
Ø60	1.80

### 776 Plastik Çıt Çıt



250

Renk	Renkli
	0.39

### 777 Bingo (M6 - M8)



200

Boy/Renk	Siyah	Renkli
M6/Küçük	0.57	0.69
M8/Küçük	0.70	0.76
M/8Büyük	0.90	1.05
Mini	0.67	0.80

### 778 Oynar Başlı Bingo



100

Boy/Renk	Ø 32
M8/inox	4.50
M10/inox	4.50
M8/Siyah	3.10
M10/Siyah	3.10

### 779 Bingo Sacı



200

Boy/Renk	Nikel
M6	0.62
M8	0.62
M10	0.62

### 780 Metal Bingo



100

Boy/Renk	Krom
10x55	7.50
10x70	8.50

**781** Plastik Masa Mentешesi

50

Renk	Kahve
	9.75

**782** Plastik Masa Mentешesi Küçük

100

Renk	Renkli
	7.50

**783** Mıknatıslı Çıt Çıt

50

Boy/Renk	Kahve
Normal	4.20
Yaylı	4.70

**784** İtici Çıt Çıt

50

Boy/Renk	Siyah
Tekli	7.75
Çiftli	14.00

**785** Çekmece Kilidi Oval

240

Boy/Renk	Krom
Oval	13.00

**786** Çekmece Kilidi Kare

240

Boy/Renk	Krom
Kare	11.00

**787** Yer Tamponu
100  
50

Boy/Renk	Krom	St/M.Krom
3,5cm	7.70	7.70
5cm	9.00	9.00

**788** Kapı Tamponu

50

Boy/Renk	Krom/St	Sarı/Beyaz
8cm	4.95	4.95
10cm	5.95	5.95
12cm	8.45	8.45
15cm	10.45	10.45

**789** Kol Tamponu

250

Renk	Şeffaf
	0.68

**790** Kol Stoperi

200

Renk	Şeffaf
	11.75





### 791 Teleskopik Ray

15

Fiyat Alınız.

Boy/Renk	Frenli	Frensiz
30cm		
35cm		
40cm		
45cm		
50cm		



### 792 Mentеше

250

Fiyat Alınız.

Boy/Renk	Frenli	Frensiz
Düz		
Y.Deve		
Deve		



### 793 Tandem Ray

15

Fiyat Alınız.

Boy/Renk	Frenli	Frensiz
30cm		
35cm		
40cm		
45cm		
50cm		



### 794 Piston

100

Fiyat Alınız.

Boy	
30nw	
60nw	
80nw	
100nw	
120nw	



### 795 Çekmece Rayı

100

Boy	
30cm	15.00
35cm	16.50
40cm	18.50
45cm	19.50
50cm	21.00



### 796 Raf Konsolu

15

Boy/Renk	Çinko	Beyaz
30cm	53.00	57.00
35cm	56.00	61.00
40cm	59.00	67.00



### 797 Streç

6

Fiyat Alınız.

Boy/Renk	17micron	23micron
2000gr		



### 798 Gizli Raf Tutucu

100

Boy	10cm	14cm
8mm	4.20	4.60
10mm	4.60	5.20

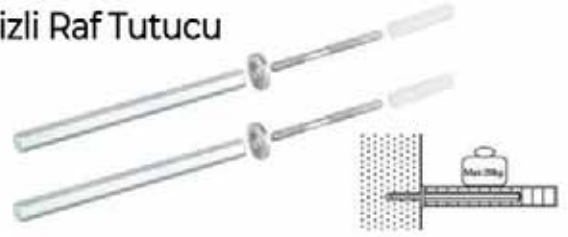

### 799 Ayakkabılık

50

Boy/Renk	Renkli
	12.90



### 800 Tamir Macunu

150

Boy/Renk	Renkli
	3.80



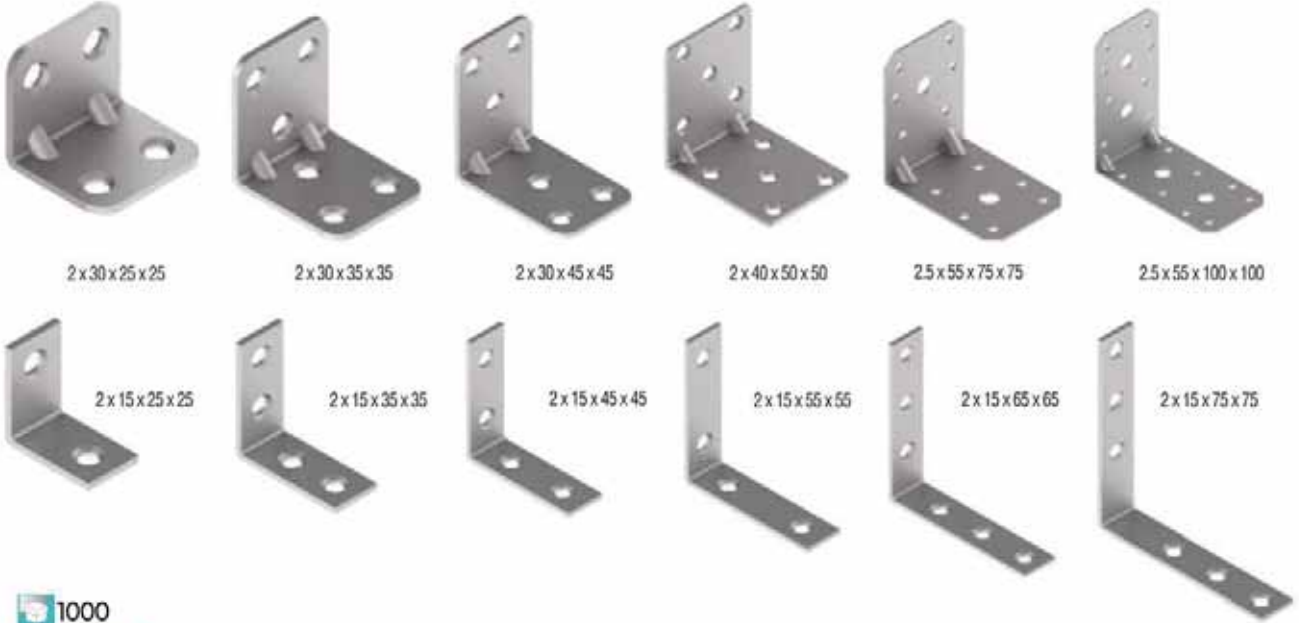

## 801 Metal L Gönve

 1000

Renk/Boy	15x25x25	15x35x35	15x45x45	17x30x30	23x30x30	25x35x35	30x25x25	30x35x35	30x45x45	40x50x50
Çinko	0.72	0.90	1.05	1.05	1.20	1.45	1.30	1.65	1.90	3.30

## 802 Metal Düz Gönve

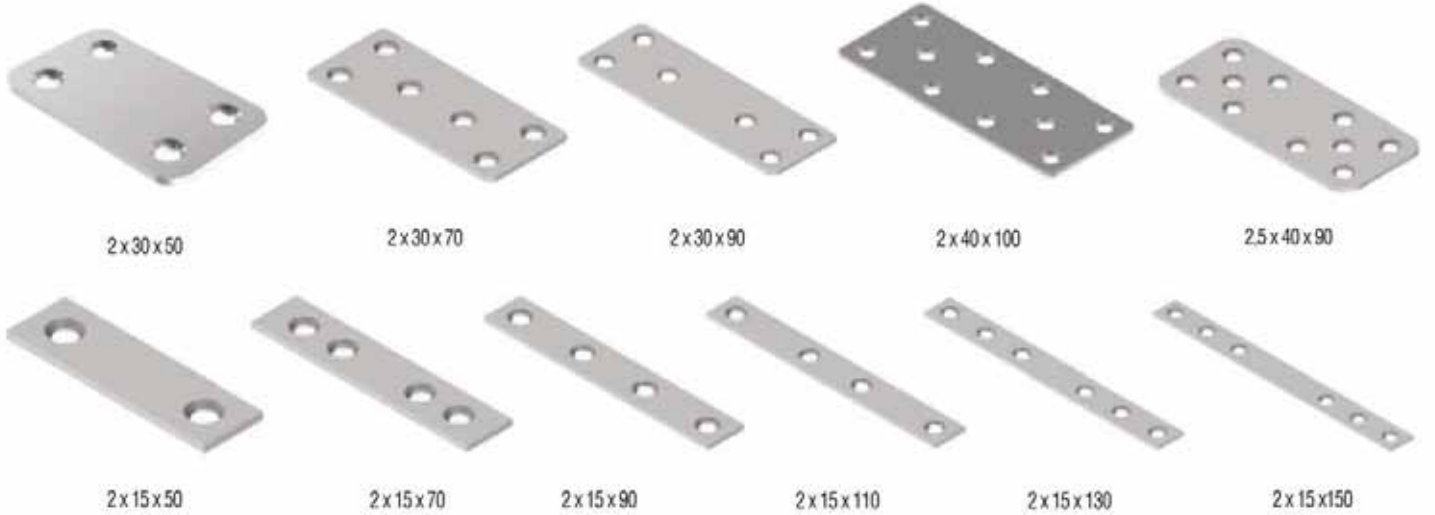
 1000

Renk/Boy	15x50	15x70	15x90	17x60	23x60	25x70	30x50	30x70	30x90	40x100
Çinko	0.72	0.90	1.05	1.05	1.20	1.45	1.30	1.65	1.85	3.30

### 803 Bar Makası



100

Renk	Beyaz	Kahve
Makas	6.00	6.00

### 804 Kalkar Kapak Makas



500

Boy/Renk	Nikel
15cm	10.20
20cm	10.50
25cm	11.20
30cm	11.60

### 805 Kapak Makası



100

Renk	Nikel
	29.00

### 806 Dübelli Karyola Demiri



10

Boy/Renk	Çinko
1.2mm	13.50
1.5mm	17.00
Sacı	2.15

### 807 Karyola Demiri



100

Boy/Renk	Janjan
9cm	15.80
12.5cm	20.80
15cm	29.00

### 808 Tırnaklı Karyola Demiri



10

Renk	Janjan
	15.00

### 809 Tv Altlığı



50

Boy/Renk	Çinko
15x15	32.00

### 810 Gardrop Asansörü



1

Renk	Krom
	240.00

### 811 Raylı Pantolonluk

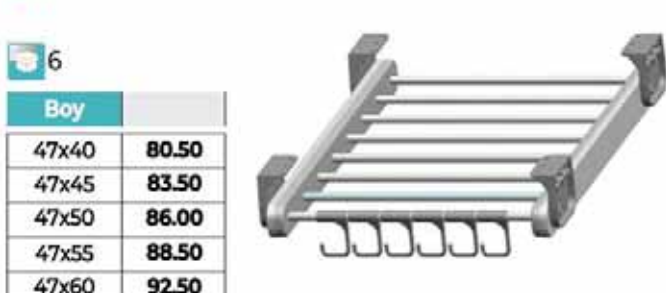

6

Boy	
47x40	80.50
47x45	83.50
47x50	86.00
47x55	88.50
47x60	92.50

### 812 Metal Kravatlık



20

Boy/Renk	Krom
30cm	14.50
35cm	14.50
40cm	14.50

### 813 Lüks Raf Altı

24  
Fiyat Alınız.

Boy/Renk	Beyaz
5x6	
6x8	
7x9	
8x10	
10x12	
12x14	



### 814 Ferforje Raf Altı

25  
Fiyat Alınız.

Boy/Renk	Renkli
11.5x15	
14.5x20	
16x23	
17.5x28	



### 815 Ayarlı Katlanır Raf Altı

24  
Fiyat Alınız.

Boy/Renk	Beyaz	Renkli
12x20		
14x25		
16x30		



### 816 Pls. Emniyet Kilidi

200  
Fiyat Alınız.

Renk	Renkli



### 817 Pls. Pencere Kolu

200  
Fiyat Alınız.

Renk	Renkli



### 818 Pls. Kapı Kolu

30  
Fiyat Alınız.

Renk	Renkli



### 819 Pls. Vasistas Çarpma

200  
Fiyat Alınız.

Renk	Renkli



### 820 Pls. D Çekme Kol

300  
Fiyat Alınız.

Renk	Renkli





## 821 Yapışkanlı Vida Tapası

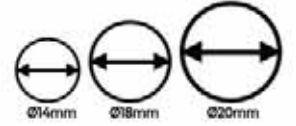

AĞAÇ RENKLERİ WOOD COLORS						
A - 7011 GÜRGEN	A - 7942 ARMUT	A - 7061 HIRAZ	A - 7059 HUŞ	A - 714E CAM	A - 6070 BAMBU	A - 3058 TIK
A - 3810 ZEYTİN	A - 7111 İTALYAN CEVİZ	A - 7225 YENİ CEVİZ	A - 7591 MILAS CEVİZ	A - 7455 KÖYÜ CEVİZ	A - 5112 DOĞAL HUŞ	A - 9003 LAREX
A - 2838 CORDOBA	A - 2041 MARBELLA KIRAZ	A - 7850 BEYAZ MEŞE	A - 7323 EĞİRCİN MEŞE	A - 4762 SONGORA MEŞE	A - 7820 MEŞE	A - 7104 WENGE
A - 7102 MAUN	A - 7383 ABANOZ	A - 5428 ZEBRANO	A - 3020 TREND BEJ	A - 3010 TREND GRİ	A - 7156 AĞIK AKÇAĞAĞAC	A - 7971 AKÇAĞAĞAC
DÜZ RENKLERİ SOLID COLORS						
A - 1110 BEYAZ	A - 1120 BEYAZ MAT	A - 1540 AYTAŞI	A - 0268 GRİ	A - 0325 BEJ	A - 8487 Pembe	A - 2110 SİYAH

PARLAK RENKLERİ HIGH GLOSS COLORS						
A - 0211 BEYAZ	A - 1951 KREM	A - 1960 SİYAH	A - 1976 VİZON	A - 1962 KIRMIZI	A - 8010 ANTRASİT	A - 1304 BAMBU
A - 3479 BEYAZ İNCİ	A - 1943 SİYAH İNCİ	A - 2284 ZEYTİN	A - 1991 AĞRIK ABANOZ	A - 7898 STAR ABANOZ	A - 8015 METALİK EMERİ	A - 7528 BEYAZ MEŞE
A - 2004 PEMBE	A - 9098 PORTAKAL	A - 8080 MURDUM	A - 4040 AKÇAĞAĞAC	A - 2583 KARAAĞAC	A - 1948 ZEBRANO	A - 4920 ANTİK LIGHT
A - 6836 CEVİZ	A - 8137 WENGE	A - 3538 CORDOBA				

Not: Parlak renklerde pakette 25 plaka, kolide 1250 plaka mevcuttur.  
There are 25 sheets in a box and 1250 sheets in a package for high gloss colors.

50

Renk	Mat Renkler
	1.20

50

Renk	Parlak Renkler
	1.60

## 822 Keçe



Ø 20	50	20 X 20	40
Ø 24	32	25 X 25	32
Ø 28	28	30 X 30	21
Ø 35	18	35 X 35	18
Ø 40	12	40 X 40	10
Ø 45	10	35 X 55	12
Ø 55	5	40 X 90	4
		120 X 240	1

50

Renk	
	3.30

## 823 Ses Stoperi



100

Boy/Renk	Naturel
8mm	5.20

### 824 Kaşıklık



15

Renk/Boy	30x49	37x49	42x49	47x49	55x49	62x49	67x49	75x49	85x49
Beyaz	46.00	57.00	61.00	66.00	70.00	78.00	87.00	98.00	105.00
Gri	41.00	53.50	58.00	62.50	65.00	73.00	77.00	84.00	95.00

### 825 Kepçelik

15

Boy/Renk	Gri
55x49	65.00
62x49	73.00



### 825-A PKM80 Sürgü Sistemi

50

Fiyat Alınız.

Renk	Çinko
PKM80	



### 826 Çöp Kovası

1

Boy/Renk	Krom
11 lt	152.00
11 lt (Eko)	110.00
14 lt	162.00



### 827 Çöp Kovası

1

Boy/Renk	Menteşeli	Raylı
16 lt	335.00	415.00



### 828 Sabit Teker

100

Boy/Renk	Siyah
22x14	1.70
26x14	3.50
28x14	3.70
32x14	4.00



### 829 U Tablı Teker

100

Boy/Renk	Siyah
Ø40	4.60
Ø50	6.00





### 830 Tablalı Teker



50

Boy/Renk	Gri	Siyah
Ø40	5.65	4.30
Ø50	6.20	4.85

### 831 Cıvatalı Teker



50

Boy/Renk	Gri	Siyah
Ø40	5.10	3.80
Ø50	5.80	4.50

### 832 Frenli Tablalı Teker



50

Boy/Renk	Gri	Siyah
Ø40	6.20	4.85
Ø50	5.95	7.30

### 833 Frenli Cıvatalı Teker



50

Boy/Renk	Gri	Siyah
Ø40	5.65	4.30
Ø50	7.00	5.65

### 834 Furç Tablalı Teker



50

Boy/Renk	Gri
Ø50	10.80
Ø75	26.30

### 835 Frenli Furç Tablalı Teker



50

Boy/Renk	Gri
Ø50	22.50
Ø75	30.00

### 836 Furç Cıvatalı Teker



50

Boy/Renk	Gri
Ø50	10.15
Ø75	24.00

### 837 Frenli Furç Cıvatalı Teker



50

Boy/Renk	Gri
Ø50	22.00
Ø75	28.00

### 838 Küre Tablalı



Boy/Renk	Siyah
Ø40	11.00

### 839 Küre Cıvatalı



50

Boy/Renk	Siyah
Ø40	10.00



### 840 Emniyet Zinciri

1

Renk	Janjan
	24.50



### 841 Emniyet Kelepçesi

1

Renk	Janjan
	27.00



### 842 Mavzer Sürgü

12

Boy/Renk	Janjan
No 4	67.50
No 6	70.00
No 8	73.00
No 10	81.00
No 12	84.00
No 14	86.50
No 16	92.00



### 843 Yaylı Sürgü

12

Renk	Janjan
Normal	57.00
Büyük	84.00



### 844 Demir Doğrama Sürgüsü Küçük

12

Renk	Janjan
	75.50



### 845 Demir Doğrama Sürgüsü Büyük

12

Renk	Janjan
	89.00



### 846 Kelebek Sürgü

12

Boy/Renk	Janjan
Küçük	54.00
Büyük	59.50

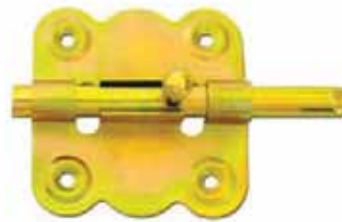

### 847 Dolap Sürgüsü 8cm

1

Boy/Renk	Janjan
Düz	7.70
Eğri	8.00



### 848 Süslü Tek Kuyruk

1

Boy/Renk	Sarı	Nikel	A. Bakır
Tek	3.70	3.70	3.70

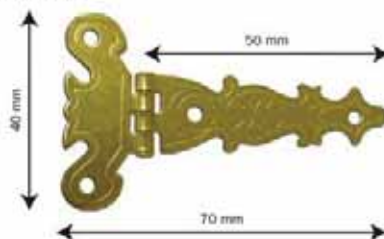

### 849 Süslü Çift Kuyruk

1

Boy/Renk	Sarı	Nikel	A. Bakır
Çift	4.00	4.00	4.00

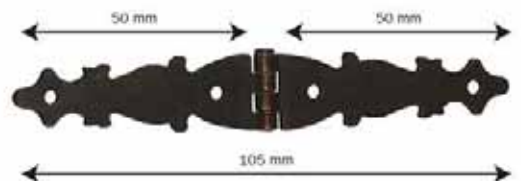

### 850 Sandık Kulbu

24

Boy/Renk	Janjan
Küçük	81.00
Büyük	108.00



### 851 Sandık Kilidi

12

Boy/Renk	Janjan
No 2	115.00
No 4	180.00



### 852 Kuyruklu Mentеше

24

Boy/Renk	Janjan
904/3	81.00
904/4	86.50
904/5	102.50
904/6	121.50
904/7	130.00



### 853 Çift Kuyruklu Mentеше

24

Boy/Renk	Janjan
900/3	102.50
900/4	116.00
900/5	135.00



### 854 Boy Mentеше

1.75mt  
3.50mt

Boy/Renk	Sarı	Siyah
1.75 mt	17.50	16.00
3.50 mt	30.00	28.00



### 855 Yaprak Mentеше

24

Boy/Renk	Janjan
1840x2	36.50
1840x2.5	41.50
1840x3	48.00
1840x3.5	72.50
1840x4	94.50
1840x5	180.00



### 856 Gömme Sürgü

1

Boy/Renk	Janjan
10cm	11.50
15cm	12.50



### 857 Sandık Askısı

12

Boy/Renk	Janjan
25	29.50
30	33.00
35	37.00



### 858 Çelik Kelebek Mentеше

1

Boy/Renk	Sarı/Antik
Küçük	3.00
Büyük	5.00

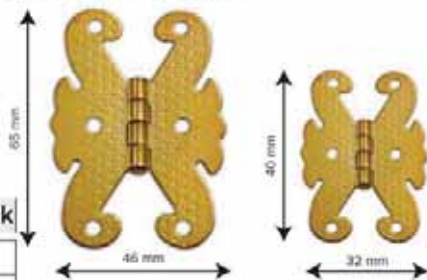

### 859 Kapazlama

12

Renk	Janjan
	160.00





**860** Çelik Kelebek Yönsüz Mentеше 10cm22  
20

Boy/Renk	Saten
2mm	6.90
2.5mm	8.20

**861** Çelik Panel Yönsüz Mentеше 12cm22  
20

Boy/Renk	Saten
2mm	6.50
2.5mm	8.20

**862** Alm. Cerman Yönsüz Mentеше 12cm

25

Boy/Renk	Alüm.	Sarı	Saten
2.5x12	11.70	11.70	11.70

**863** Alm. Cumbalı Mentеше25  
20

Boy/Renk	Alüm.	Sarı
2.5x10	14.50	14.50
2.5x12	16.50	16.50

**864** Çelik Okka Mentеше 10cm  
Köşeli/Oval

20

Boy/Renk	Saten
2.5x10	14.50

**865** Çelik Panel Mentеше 10cm

16

Boy/Renk	Saten
2.5x10	15.00

**866** Bar Mentешesi

2

Boy/Renk	Nikel	Saten
75mm	215.00	215.00
100mm	270.00	270.00
125mm	300.00	300.00
150mm	390.00	390.00

**867** Kapı İtme Yayı

1

Boy/Renk	
8mm	85.00





**868** Tek Yönlü Yaylı Mentеше

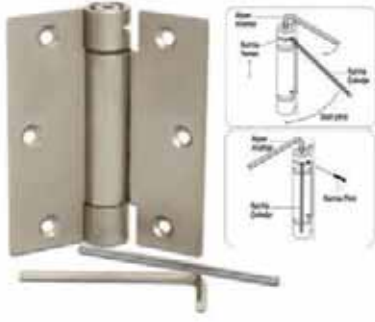

1	Boy/renk	Saten
	3mm	185.00

**869** Tek Yönlü Kelebek Yaylı Mentеше



1	Boy/renk	Saten
	3mm	185.00

**870** Merdiven Mentешesi



12	Boy/renk	Janjan
		108.00

**871** Vidalı Kapı Mentешesi Düz-Tablalı



50	Boy/renk	Metal
	Düz	10.80
	Tablalı	10.80

**872** Barel



40	Fiyat Alınız.	Boy
		Oda
		Yale
		WC

**873** Kilit



40	Fiyat Alınız.	Boy	Metal	PVC
		Oda		
		Yale		
		WC		

**874** WE-103



Fiyat Alınız.	Boy/renk	Gri
	Ø38	

**875** WE-007



Fiyat Alınız.	Boy/renk	Gri
	40x40	

**876** WE-193

Fiyat Alınız.

Boy/Renk	Gri
49x96	

**877** WE-142

Fiyat Alınız.

Boy/Renk	Gri
43.5x76	

**878** Pera-034

Fiyat Alınız.

Boy/Renk	Krom

**879** WE-4345

Fiyat Alınız.

Boy/Renk	Gri
50x77	

**878** Pera-036

Fiyat Alınız.

Boy/Renk	Krom

**879** Pera-040

Fiyat Alınız.

Boy/Renk	Krom

**882** Pera-041

Fiyat Alınız.

Boy/Renk	Krom

**883** Pera-043

Fiyat Alınız.

Boy/Renk	Krom

**884** Endüstriyel-017

Fiyat Alınız.

Boy/Renk	Krom

**885** Duş Seti

Fiyat Alınız.

Boy/Renk	Krom

kiler sistemleri  
larder systems



### 886 Aspiratör

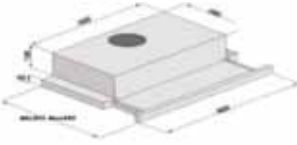

Genişlik	: 60 cm
Baca Çıkış Çapı	:120 mm
Motor Gücü	:2x95 Watt
Motor Adedi	:Çift Motor
Aydınlatma	:2x25W Lamba
Kontrol	:Switch
Hava Debisi	:500 m <sup>3</sup> /h
Filtre Tipi	:Alüminyum
Filtre Adedi	:Tek Filtre
Ses Seviyesi	:51 DbA

Fiyat Alınız.

Renk	İnox	Beyaz



### 887 Davlumbaz



Genişlik	: 60 cm
Baca Çıkış Çapı	:120 mm
Motor Gücü	:190 Watt
Aydınlatma	:2x25W Lamba
Kontrol	:Basmalı Buton
Hava Debisi	:650 m <sup>3</sup> /h
Filtre Tipi	:Alüminyum
Ses Seviyesi	:56 DbA
Renk	:İnox

Fiyat Alınız.

Renk	İnox	Beyaz



### 888 Folyoluk-Havluluk



Boy/Renk	Krom
Havluluk	<b>104.00</b>
İkili	<b>117.00</b>
Üçlü	<b>130.00</b>



### 889 Baharatlık



Boy/Renk	Krom
Tekli	<b>104.00</b>
İkili	<b>117.00</b>



### 890 Yandan Teleskopik Raylı Şişelik



EKO

Boy/Renk	Teleskopik	Frenli
11x46x48	<b>170.00</b>	<b>225.00</b>
16x46x48	<b>185.00</b>	<b>240.00</b>

Boy/Renk	Teleskopik	Frenli
11x46x48	<b>195.00</b>	<b>245.00</b>
11x51x48	<b>195.00</b>	<b>245.00</b>



### 891 Yandan Teleskopik Raylı Deterjanlık



Boy/Renk	Teleskopik	Frenli
16x46x48	<b>210.00</b>	<b>260.00</b>
16x51x48	<b>210.00</b>	<b>260.00</b>
21x46x48	<b>220.00</b>	<b>275.00</b>
21x51x48	<b>220.00</b>	<b>275.00</b>



### 892 Kiler

Kapak
30cm
35cm
40cm
45cm
50cm

Boy/Renk	Teleskopik	Frenli
60x80	<b>585.00</b>	<b>660.00</b>
80x95	<b>650.00</b>	<b>725.00</b>
95x110	<b>715.00</b>	<b>795.00</b>
110x125	<b>780.00</b>	<b>850.00</b>
125x140	<b>845.00</b>	<b>925.00</b>
140x155	<b>910.00</b>	<b>990.00</b>
155x170	<b>975.00</b>	<b>1050.00</b>
170x185	<b>1040.00</b>	<b>1120.00</b>
185x200	<b>1105.00</b>	<b>1180.00</b>
200x215	<b>1170.00</b>	<b>1250.00</b>



### 893 Teleskopik Raylı Çekmece

Kapak
35cm
40cm
45cm
50cm
55cm
60cm

Boy/Renk	Teleskopik	Frenli
30x50	<b>170.00</b>	<b>220.00</b>
35x50	<b>180.00</b>	<b>235.00</b>
40x50	<b>195.00</b>	<b>245.00</b>
45x50	<b>205.00</b>	<b>260.00</b>
50x50	<b>220.00</b>	<b>275.00</b>
55x50	<b>235.00</b>	<b>290.00</b>



### 894 Ahşap Tabanlı Döner Sepet



Boy	3/4	4/4
740x650-700	<b>0.00</b>	<b>0.00</b>



### 895 Döner Sepet



Boy	Boy		Boy
	1/2	3/4	
560x650-700	<b>340.00</b>	460x650-700 <b>340.00</b>	560x650-700 <b>365.00</b>
720x650-700	<b>350.00</b>	720x650-700 <b>360.00</b>	720x650-700 <b>375.00</b>



### 896 Askılı Çamaşır Sepeti

Boy/Renk	Kapak	Teleskopik
23x26x46	30cm	<b>105.00</b>
23x26x56	30cm	<b>115.00</b>
28x26x46	35cm	<b>110.00</b>
28x26x56	35cm	<b>125.00</b>
33x26x46	40cm	<b>115.00</b>
33x26x56	40cm	<b>130.00</b>
38x26x46	45cm	<b>125.00</b>
38x26x56	45cm	<b>135.00</b>
43x26x46	50cm	<b>130.00</b>
43x26x56	50cm	<b>145.00</b>
48x26x46	55cm	<b>135.00</b>
48x26x56	55cm	<b>150.00</b>
53x26x46	60cm	<b>145.00</b>
53x26x56	60cm	<b>155.00</b>



### 897 Kapağa Monte Çamaşır Sepeti

Boy/Renk	Kapak	Teleskopik
23x26x40	30cm	<b>80.00</b>
23x26x46	30cm	<b>90.00</b>
28x26x40	35cm	<b>85.00</b>
28x26x46	35cm	<b>95.00</b>
33x26x40	40cm	<b>90.00</b>
33x26x46	40cm	<b>105.00</b>
38x26x40	45cm	<b>100.00</b>
38x26x46	45cm	<b>110.00</b>
43x26x40	50cm	<b>105.00</b>
43x26x46	50cm	<b>115.00</b>
48x26x40	55cm	<b>110.00</b>
48x26x46	55cm	<b>125.00</b>
53x26x40	60cm	<b>115.00</b>
53x26x46	60cm	<b>130.00</b>



**kapı kolları**  
door handles



**898** Yaprak Aynalı



50

Kare ayna için fiyat sorunuz.

Boy/Renk	Nikel/Saten	Sarı	Siyah
Oda	36.50	39.00	39.00
Yale	36.50	39.00	39.00
WC	41.50	44.00	44.00

**899** Yaprak Rozetli



50

Kare ayna için fiyat sorunuz.

Boy/Renk	Nikel/Saten	Sarı	Siyah
Oda	41.50	44.00	44.00
Yale	41.50	44.00	44.00
WC	47.00	49.50	49.50

**900** Bravo Aynalı



50

Kare ayna için fiyat sorunuz.

Boy/Renk	Nikel/Saten	Sarı	Siyah
Oda	28.50	31.50	31.50
Yale	28.50	31.50	31.50
WC	34.00	36.50	36.50

**901** Bravo Rozetli



50

Kare ayna için fiyat sorunuz.

Boy/Renk	Nikel/Saten	Sarı	Siyah
Oda	34.00	36.50	36.50
Yale	34.00	36.50	36.50
WC	39.00	41.50	41.50

**902** Tombik Aynalı



50

Kare ayna için fiyat sorunuz.

Boy/Renk	Nikel/Saten	Sarı	Siyah
Oda	36.50	39.00	39.00
Yale	36.50	39.00	39.00
WC	41.50	44.00	44.00

**903** Tombik Rozetli



50

Kare ayna için fiyat sorunuz.

Boy/Renk	Nikel/Saten	Sarı	Siyah
Oda	41.50	44.00	44.00
Yale	41.50	44.00	44.00
WC	47.00	49.50	49.50

## 904 Kartal



Kare ayna için fiyat sorunuz.

Boy/Renk	Nikel/Saten	Sarı	Siyah
Oda	36.50	39.00	39.00
Yale	36.50	39.00	39.00
WC	41.50	44.00	44.00

50

## 905 Kartal Rozetli



Kare ayna için fiyat sorunuz.

Boy/Renk	Nikel/Saten	Sarı	Siyah
Oda	36.50	39.00	39.00
Yale	36.50	39.00	39.00
WC	41.50	44.00	44.00

50

## 906 Kalın



Kare ayna için fiyat sorunuz.

Boy/Renk	Nikel/Saten	Sarı	Siyah
Oda	39.00	41.50	41.50
Yale	39.00	41.50	41.50
WC	44.50	47.00	47.00

50

## 907 Kalın Rozetli



Kare ayna için fiyat sorunuz.

Boy/Renk	Nikel/Saten	Sarı	Siyah
Oda	39.00	41.50	41.50
Yale	39.00	41.50	41.50
WC	44.50	47.00	47.00

50

## 908 Noktalı



Kare ayna için fiyat sorunuz.

Boy/Renk	Nikel/Saten	Sarı	Siyah
Oda	39.00	41.50	41.50
Yale	39.00	41.50	41.50
WC	44.50	47.00	47.00

50

## 909 Noktalı Rozetli



Kare ayna için fiyat sorunuz.

Boy/Renk	Nikel/Saten	Sarı	Siyah
Oda	39.00	41.50	41.50
Yale	39.00	41.50	41.50
WC	44.50	47.00	47.00

50

**910** Parçalı



Kare ayna için fiyat sorunuz.

Boy/Renk	Nikel/Saten	Sarı	Siyah
Oda	39.00	41.50	41.50
Yale	39.00	41.50	41.50
WC	44.50	47.00	47.00

50

**911** Parçalı Rozetli



Kare ayna için fiyat sorunuz.

Boy/Renk	Nikel/Saten	Sarı	Siyah
Oda	47.00	50.00	50.00
Yale	47.00	50.00	50.00
WC	52.00	54.50	54.50

50

**912** Dalgalı



Kare ayna için fiyat sorunuz.

Boy/Renk	Nikel/Saten	Sarı	Siyah
Oda	39.00	41.50	41.50
Yale	39.00	41.50	41.50
WC	44.50	47.00	47.00

50

**913** Dalgalı Rozetli



Kare ayna için fiyat sorunuz.

Boy/Renk	Nikel/Saten	Sarı	Siyah
Oda	47.00	50.00	50.00
Yale	47.00	50.00	50.00
WC	52.00	54.50	54.50

50

**914** Elegant Parçalı



Kare ayna için fiyat sorunuz.

Boy/Renk	Nikel/Saten	Sarı	Siyah
Oda	39.00	41.50	41.50
Yale	39.00	41.50	41.50
WC	44.50	47.00	47.00

50

**915** Elegant Parçalı Rozetli



Kare ayna için fiyat sorunuz.

Boy/Renk	Nikel/Saten	Sarı	Siyah
Oda	47.00	50.00	50.00
Yale	47.00	50.00	50.00
WC	52.00	54.50	54.50

50



### 916 Dokuz Noktalı



Kare ayna için fiyat sorunuz.

Boy/Renk	Nikel/Saten	Sarı	Siyah
Oda	39.00	41.50	41.50
Yale	39.00	41.50	41.50
WC	44.50	47.00	47.00

50

### 917 Dokuz Noktalı Rozetli



Kare ayna için fiyat sorunuz.

Boy/Renk	Nikel/Saten	Sarı	Siyah
Oda	39.00	41.50	41.50
Yale	39.00	41.50	41.50
WC	44.50	47.00	47.00

50

### 918 Can



Kare ayna için fiyat sorunuz.

Boy/Renk	Nikel/Saten	Sarı	Siyah
Oda	39.00	41.50	41.50
Yale	39.00	41.50	41.50
WC	44.50	47.00	47.00

50

### 919 Can Rozetli



Kare ayna için fiyat sorunuz.

Boy/Renk	Nikel/Saten	Sarı	Siyah
Oda	39.00	41.50	41.50
Yale	39.00	41.50	41.50
WC	44.50	47.00	47.00

50

### 920 Cansu



Kare ayna için fiyat sorunuz.

Boy/Renk	Nikel/Saten	Sarı	Siyah
Oda	39.00	41.50	41.50
Yale	39.00	41.50	41.50
WC	44.50	47.00	47.00

50

### 921 Cansu Rozetli



Kare ayna için fiyat sorunuz.

Boy/Renk	Nikel/Saten	Sarı	Siyah
Oda	39.00	41.50	41.50
Yale	39.00	41.50	41.50
WC	44.50	47.00	47.00

50

**922** Piramit Klapa



Boy/Renk	Sarı/Krom
20cm	6.25
32cm	11.00

50

**923** Çubuk Broş



Boy/Renk	Sarı/Krom
Broş	0.65

5000

**924** Çivili Kabara

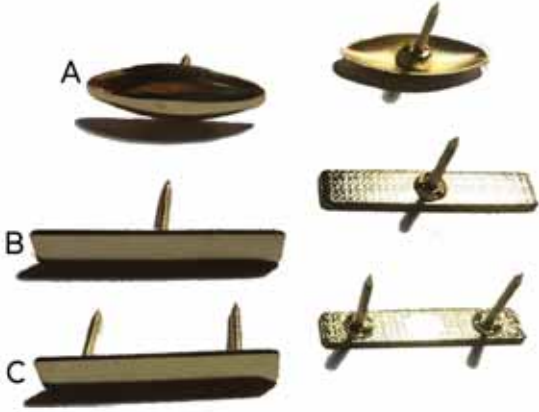

Boy/Renk	Sarı/Krom
Kabara	0.90

3000

**925** Çivili Kabara

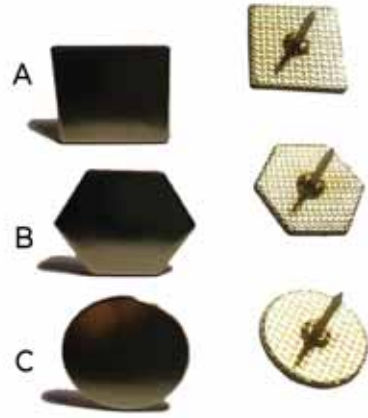

Boy/Renk	Sarı/Krom
Kabara	0.90

3000

**926** Pls. Sarkaç



Boy/Renk	Sarı/Krom
Sarkaç	3.00

100

**927** Pls. Düğme



Boy/Renk	Sarı/Krom
Düğme	3.00

100

## 928 Sunta Vidası



## SUNTA VIDA FİYAT LİSTESİ

ÖLÇÜ	KUTU/AD.	KOLİ/AD.	FİYAT TL/1.000 Ad.
3.5x16 mm Sunta Vidası	1.000	32.000	
3.5x18 mm Sunta Vidası	1.000	24.000	
3.5x20 mm Sunta Vidası	1.000	24.000	
3.5x25 mm Sunta Vidası	1.000	16.000	
3.5x30 mm Sunta Vidası	1.000	16.000	
3.5x35 mm Sunta Vidası	1.000	12.000	
3.5x40 mm Sunta Vidası	500	8.000	
3.5x50 mm Sunta Vidası	500	6.000	
4x18 mm Sunta Vidası	1.000	16.000	
4x20 mm Sunta Vidası	1.000	16.000	
4x25 mm Sunta Vidası	500	12.000	
4x30 mm Sunta Vidası	500	12.000	
4x35 mm Sunta Vidası	500	8.000	
4x40 mm Sunta Vidası	500	8.000	
4x45 mm Sunta Vidası	500	6.000	
4x50 mm Sunta Vidası	500	6.000	
4x60 mm Sunta Vidası	500	4.000	
4x70 mm Sunta Vidası	200	3.200	
4.5x50 mm Sunta Vidası	500	4.000	
5x40 mm Sunta Vidası	500	6.000	
5x45 mm Sunta Vidası	200	32.000	
5x50 mm Sunta Vidası	200	32.000	
5x60 mm Sunta Vidası	200	32.000	
5x70 mm Sunta Vidası	200	2.400	
5x80 mm Sunta Vidası	200	1.600	
5x100 mm Sunta Vidası	100	1.200	
6x60 mm Sunta Vidası	200	2.400	
6x70 mm Sunta Vidası	100	1.600	
6x80 mm Sunta Vidası	100	1.200	
6x100 mm Sunta Vidası	100	1.200	
6x120 mm Sunta Vidası	125	1.000	
3.5x25 mm Arkalık Vidası	1.000	16.000	



20

21

# 20

# 21



[www.ilkeyfurniture.com](http://www.ilkeyfurniture.com)  
[www.ilkeyaksesuar.com](http://www.ilkeyaksesuar.com)  
[www.cosmosaks.com](http://www.cosmosaks.com)

[info@cosmosaksesuar.com](mailto:info@cosmosaksesuar.com)  
[info@ilkeyaksesuar.com](mailto:info@ilkeyaksesuar.com)  
[export@ilkeyfurniture.com](mailto:export@ilkeyfurniture.com)